

THE
CORELLIAN
ENGINEERING CORPORATION
SOURCEBOOK

COMPENDIUM



BY KEITH A. KILBURN



THE CORELLIAN ENGINEERING CORPORATION SOURCEBOOK COMPENDIUM

By Keith A. Kilburn

With Contributions by various members of the Rancorpit forums.

Editing and formatting by Don Diestler and Daniel Stull.

Cover and layout by Peter Lomas and Don Diestler.

Special Thanks to: Dawn Kilburn, Peter C. Spahn, Derek (Dude) Thornton, Larry Parr, Jimmy Bramble, Seth Walker, Greg Clark, Justin and Stephanie Jones, Ronnie Rich, Robert Maxwell, Kevin Rowell, Glenn and Tim Moss, Paul Umbarger, Daniel Stull and Don Diestler.

Published 2015 version 1



CONTENTS

CEC COMPENDIUM

Credits	1	Chapter 9	Scout Ships	63	
Contents	2	Chapter 10	YV Freighters	66	
Preface	3	Chapter 11	YX Freighters	76	
Chapter 1	YT Vessels	4	Chapter 12	YZ Freighters	78
Chapter 2	Bulk Transports and Yachts	32	Chapter 13	Corvettes	82
Chapter 3	CRF Transports	38	Chapter 14	Frigates	133
Chapter 4	VCX Freighters	41	Chapter 15	Cruisers	150
Chapter 5	XS Freighters	50	Chapter 16	Heavy Cruisers	153
Chapter 6	YB and YC Transports	53	Chapter 17	Star Defenders	155
Chapter 7	YG Transports	56	Chapter 18	Miscellaneous Ships	158
Chapter 8	YI/YR/YU Freighters	59			



PREFACE

When the two founders of the Corellian Engineering Corporation started the company with a little seed money they had managed to gather from family and friends, beings throughout the Corellian system laughed and derided them for their vision of wanting to make quality space craft at affordable prices. No one expected Awvrell and Ilbourne Wayrcn to take the Corellian system by storm and forever turn shipwright manufacturing on its head by taking a company that started off in the backyard of the two brothers and turning it into one of the three largest manufacturers throughout the known galaxy and perhaps the most prolific manufacturer of the group.

Once the Corellian Engineering Corps, the original name for the Corellian Engineering Corporation, established itself it became a long standing part of the Techno Union and building a permanent corporate headquarters located on C.E.C. Island, in the heart of Coronet the capital of Corellia. At the heart of company the dream of the Wayrcn brothers has always remained the same.

“We’re building and designing ships for the civilians and free traders, using the knowledge gathered from the people who work on, dream of, and want to pass along what they have learned to keep ships in sky and blazing new trails to distant locations and brighter futures...”

–Awvrell Wayrcn

The Wayrcn brothers really didn’t want to participate in politics or military related contracts, not that they saw anything wrong with those noble pursuits, but rather they just wanted to concentrate on the largely ignored civilian market and so using skilled designers, starship engineers and shipwrights they created shipyard that were well known for their modular freighters which could be upgraded easily for both comfort and combat if necessary.

“Whether we’re teaming up with Loronar Corporation to jointly fund The Nerfworks, a think tank responsible for a number of starship designs, including some droid starships, or jointly owning Chempat Engineered Defenses with Kuat Drive Yards, we’ve kept jobs on Corellia and for Corellians by creating and funding subsidiaries that helped bolster the planetary economy. When the senior design team of Corellia StarDrive was killed in a shuttle crash, we bought the com-

pany to help keep those working diligently for the betterment of Corellian employed.

Gathered here for the first time is an accounting of the many freighter transports that we’ve manufactured since the beginning of the Corellian Engineering Corps including technical specifications, original production designs, as well as technical commentary by famed Corellian war hero, two time winner of the Corellian blood-stripe for valor and bravery and one of our most outspoken supporters, General Han Solo and a host of other famous Corellians.”

“The Millennium Falcon is the ship that made the Kessel Run in less than twelve parsecs. I’ve outrun Imperial starships, not the local bulk-cruisers, mind you. I’m talking about the big Corellian ships now...”

–General Han Solo

Over four thousand years in business and countless ships sold and purchased by numerous satisfied customers, no one is laughing anymore.

**Mal’crt Wayrcn,
Proud owner of the C.E.C.**

**The views expressed by General Solo and others are theirs alone and do not represent the views and opinions of the Corellian Engineering Corporation, its ownership, management or employees.*

In the minds of most consumers and the layman the YT class freighter *is* the face of the Corellian Engineering Corporation and for the most part there is a truth to that belief, the C.E.C. has sold more YT’s over the last four hundred and fifty years then they’ve sold most anything else. There are three billion sentient beings living on Corellia and over the last four and half centuries they’ve sold six times that number in YT-Freighters. For a while there, the YT-freighter, especially the ‘1300, is all you saw flying through the sky and then the many imitators started producing their own freighters in an effort to steal some of the market share held by the C.E.C.

CHAPTER 1

YT VESSELS

Ghtroc Industries, Kuat Drive Yards and the Sienar fleet systems all failed to follow the trail they blazed in their success.

Now you might be asking yourself, how did the Corellian Engineering Corporation happen to blaze this trail, what allowed them to be so fortunate? Well, just like with the Wayrcn brothers all those years ago; Kalz'Dac Navarro had a dream about a series of compartmentalized cargo ships. Ships that could be used by anyone for just about anything, where parts were interchangeable and where the ship could easily be modified by its owner at a moment's notice. Its saucer shaped hull and ease of modification turned out to be immensely popular among its many purchasers through out a wide spectrum of social strata.

How best to explain what it was that Kalz'Dac Navarro was attempting to do, then to present his own words on the subject...

'I wanted to race pods. I didn't like school, and all I wanted to do was work on my pod-racer. But right before I graduated and would have gone off for my secondary schooling, I got into a really bad racing accident, and I spent that summer in the med-center thinking about where I was heading. I decided to take education more seriously and go to an engineering school. I had a simple dream; I wanted to give everyone who bought a C.E.C. related product the same feeling of exhilaration that I got when I was behind the controls of my pod-racer. It took a little while to get all the details right, and it may come as a shock that the initial design for the YT was based on a sandwich I was eating at the time, but through hard work and determination I was able to give that feeling to anyone who ever dreamed of escaping their life and running off on an adventure by designing the first of many YT-freighters...'

—Kalz'Dac Navarro

A boy's dream to escape and see adventure translated into physical form for others to follow the trail that he blazed; a trail emulated by the many free traders and ship owners throughout the years, some of them as famous as General Han solo, war hero of the galactic civil war and two time winner of the Corellian blood-stripe for valor and bravery,

others like Kazdan Navarro, a descendent of Kalz'Dac who had to pull himself up by his boot-straps after his father Karlz'dan Navarro the III, the famous Corellia ambassador to Alderan was killed alongside his wife during the first real use of the Deathstar weapons platform. And then there is Dash Render...but the less said about him, the better.

In the end it doesn't matter if you're flying the Millennium Falcon, the Centennial Hawk or even the Outrider, as long as you're making the jump to light-speed in search of your own adventures wherever that might take you.

**General Wedge Antilles,
Corellian war hero and leader of Rogue Squadron.**

YT-450A

LIGHT FREIGHTER

Craft: Corellian Engineering Corporation YT-450a
Transport

Type: Light freighter

Era: Rise of the Empire

Affiliation: General

Source: Inferred-Gamemasters Handbook, Pg. 60

Scale: Starfighter

Length: 25 meters

Skill: Space Transports

Crew: 1 to 2 (can coordinate)

Crew Skill: Varies widely

Passengers: 4

Cargo Capacity: 95 metric tons

Consumables: 2 months

Cost: 24,500 credits (used only)

Hyperdrive Multiplier: x3

Hyperdrive Backup: x15

Nav Computer: Yes

Maneuverability: +1

Space: 3

Atmosphere: 260; 750 kmh

Hull: 4D

Shields: 1D

Sensors:

Passive: 10/0D

Scan: 25/1D

Search: 40/2D

Focus: 2/3D

Weapons:

Laser Cannon

Fire Arc: Turret

Crew: 1 (co-pilot)

Scale: Starfighter

Skill: Starship gunnery

Fire Control: 2D

Space Range: 1-3/12/25

Atmosphere: 100-300/1.2/2.5 km

Damage: 4D

Capsule: The YT-450a was one of the very first designs of the Corellian Engineering Corporation (C.E.C.) for the light freighter market. It sold quite well in the days of the Old Republic where it was released, but as C.E.C. quickly developed and released newer and improved freighters, the YT-450a slowly lost its attractiveness. Free traders now preferred freighters like the YT-1200, YT-1210 and of course the famous YT-1300 transport. There were some models between these and the YT-450a, such as the YT-700 and the YT-1000, but they didn't have high production numbers. However the freighters following the YT-1000 were quite popular and still are! Especially the YT-1300. They all featured better hyperspace and sub-light speed, larger cargo bays and could easily be modified, things that the YT-450a could not compete with.



Addendum Personal- General Han Solo

Despite what Chewie and my wife will tell you, I'm not old enough to have actually flown one of these and what little I know about this fairly obscure C.E.C. ship is that it flies something like a permecrete brick being thrown from a moving land speeder. If you can find one my suggestion would be to use it strictly for getting around in system and avoid all of the firefights that you can while going about your business. As ships go, they're not awful...just old, but reliable or so I am told...

YT-700

LIGHT FREIGHTER

Craft: Corellian Engineering Corp. YT-700

Transport

Type: Light Freighter

Era: Rise of the Empire

Affiliation: General

Source: Official-Adventure Journal 5

Scale: Starfighter

Length: 21.7 meters

Skill: Space transports: YT-700 transport

Crew: 1, gunner: 1

Crew Skill: Varies widely

Passengers: 4

Cargo Capacity: 65 metric tons

Consumables: 2 months

Cost: 18,000 credits (used only)

Hyperdrive Multiplier: x2

Hyperdrive Backup: x20

Nav Computer: Yes

Maneuverability: 0D

Space: 3

Atmosphere: 210; 600 kmh

Hull: 4D

Shields: 1D

Sensors:

Passive: 10/0D

Scan: 25/1D

Search: 40/2D

Focus: 2/3D

Weapons:

Laser Cannon

Fire Arc: Turret

Crew: 1

Scale: Starfighter

Skill: Starship gunnery

Fire Control: 0D

Space Range: 1-3/12/25

Atmosphere: 100-300/1.2/2.5 km

Damage: 4D

Capsule: The YT-700 was a transport starship manufactured by Corellian Engineering Corporation. It was one of the first freighters of the YT series.

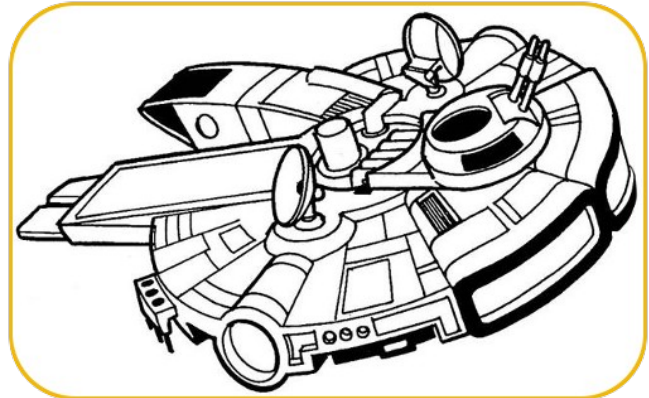

Addendum Personal- General Han Solo

There really isn't much that I can say about this ship that already hasn't been said. They never caught on like anyone thought that they would, however the cylindrical shape and cockpit became something of a reoccurring feature for most of the C.E.C.'s ship lines. This baby is a workhorse and while you don't see them around as much as you used to, they get the job done...

YT-920 LIGHT FREIGHTER

Craft: Corellian Engineering Corporation's YT-920 Transport

Type: Stock light freighter

Era: Rebellion

Affiliation: General

Source: Arbitrary / Random-RPGgamer.org

Scale: Starfighter

Length: 32.6 meters

Skill: Space transports: YT-920

Crew: 2

Crew Skill: Varies widely

Passengers: 5

Cargo Capacity: 85 metric tons

Consumables: 2 months

Cost: 100,000 (new), 30,000 (used), 15,000 (used - Imperial Era)

Hyperdrive Multiplier: x3

Hyperdrive Backup: x22

Nav Computer: Limited to 5 jumps

Maneuverability: 1D

Space: 4

Atmosphere: 280; 800 kmh

Hull: 3D

Shields: 1D

Sensors:

Passive: 10/0D

Scan: 25/1D

Search: 40/2D

Focus: 2/3D

Weapons:

Blaster Cannon

Fire Arc: Right turret

Crew: 1

Scale: Starfighter

Skill: Starship gunnery

Fire Control: 1D

Space Range: 1-3/12/25

Atmosphere Range: 100-300/1.2/2.5 km

Damage: 3D

Capsule: The Corellian YT-920 light freighter was first introduced two years following the release of Corellian star cruiser which gained much fame serving as a priority diplomatic transport for the Republic. The YT-920 is a direct ancestor to many later designs - the YT-1210, YT-1300 and YT-2400 transports - and sports many of the same features. Like later models in the YT-series, the YT-920 consists of a disc-shaped fuselage with a cockpit extending off of the left side in an almost identical fashion as the YT-1300 (except on the opposite side of the vessel). On the ship's right side is a Corellian blaster cannon turret designed to be easily replaced by larger, more powerful weaponry at a later time.

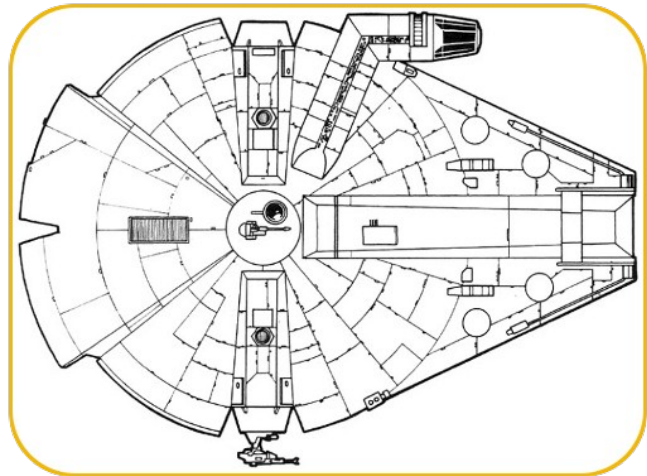

Addendum Personal- General Han Solo

I can't say that I've ever seen one of these in all my travels and I have been from one side of the universe to the other, I even asked Chewie if he had seen one and he said that after drinking some spiced nog one Life Day that he thought that he might have seen one... The first thing that I notice is that it lacks the cargo mandibles on the front and the C.E.C. used the V-Tech engine design, not too shabby. She's got a pretty look to her, but I like rounder curves on my ladies and less straight lines.

YT-1000 LIGHT FREIGHTER

Craft: Corellian Engineering Corporation YT-1000 Transport

Affiliation: General

Type: Light freighter

Era: Rebellion

Source: Fanmade-Keith Kilburn

Scale: Starfighter

Length: 28 meters

Skill: Space transports: YT-1000

Crew: 1, gunners: 1, skeleton: 1

Crew Skill: Varies widely

Passengers: 4

Cargo Capacity: 75 metric tons

Consumables: 2 months

Cost: 85,000 credits new, 20,000 used

Hyperdrive Multiplier: x3

Hyperdrive Backup: x16

Nav Computer: Yes

Space: 4

Atmosphere: 460; 740 kmh

Hull: 4D

Shields: 1D

Sensors:

Passive: 10/0D

Scan: 25/1D

Search: 40/2D

Focus: 2/3D

Weapons:

Double Laser Cannon

Fire Arc: Turret

Crew: 1

Scale: Starfighter

Skill: Starship gunnery

Fire Control: 1D

Space Range: 1-3/12/25

Atmosphere Range: 100-300/1.2/2.5 km

Damage: 4D

Capsule: The YT-1000 light freighter was a freighter produced by Corellian Engineering Corporation. It bore distinct similarities to its successor, the YT-1300 light freighter. It was a smaller vessel, and featured a top-mounted cockpit. It had been initially intended as well as a potential replacement for the venerable Barloz-class Me-

dium Freighters, although even the C.E.C. had not envisioned it as a bold new direction in starship design.. As with the later variants of the YT series, the YT-1000 was favored by smugglers, who enjoyed the freedom to tinker with the vessel and add many modifications, such as various weaponry. The model was replaced by the many variants in the YT-1000 line, the YT-1200 line and later still the YT-1300.

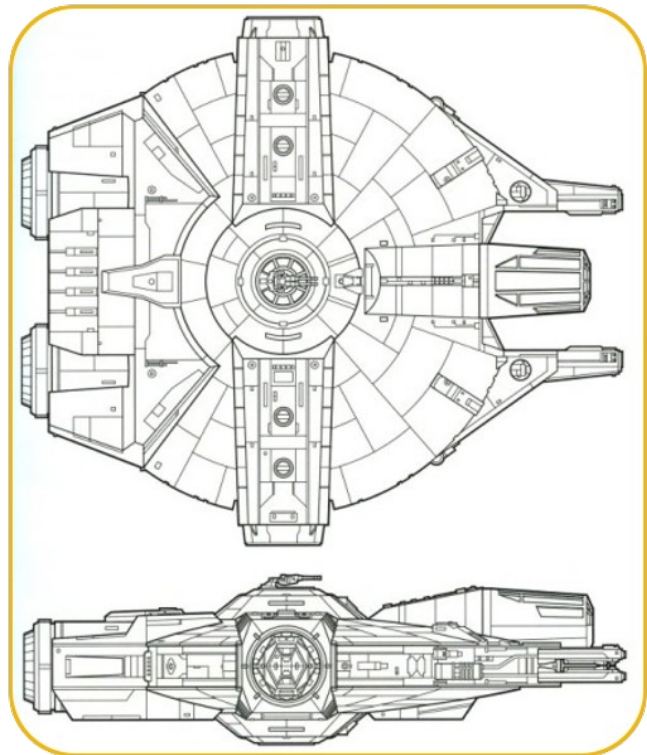

Addendum Personal- General Han Solo

The 1000 was still in pretty heavy use while I was working my way up through the ranks as a pilot, the C.E.C. used the Bi-Engine configuration and center column cockpit eliminating the cargo mandibles and front loading that became standard features in the '1300'. The downside is that you the pilot are loading everything through the entry ramp and let me tell you from some of my vast experience, this is not something you want to do during a rainstorm, being chased by angry natives or a pack of Imps hell-bent on catching you. Not a bad little ship, but the C.E.C. had a long way to go before they got it right...

YT-1050

LIGHT FREIGHTER

Atmosphere Range: 100-300/1.2/2.5 km

Damage: 4D

Capsule: This limited run of YT-class freighters came about as an attempt to offset losses from the YT-900 and YT-1000 class freighters, problems arose when the parts used in production went over budget and the initial design lines were scrapped and most of them were mothballed saved for one that was stolen by a pirate operating near Zeltron.

Craft: Corellian Engineering Corporation YT-1050
Transport

Type: Light freighter

Era: Rebellion

Affiliation: General

Source: Arbitrary, Random-Tetsuoh from the Rancor Pits forums

Scale: Starfighter

Length: 28.6 meters

Skill: Space transports: YT-1050

Crew: 1, gunners: 1, skeleton: 1

Crew Skill: Varies widely

Passengers: 6

Cargo Capacity: 100 metric tons

Consumables: 2 months

Cost: 135,000 new

Hyperdrive Multiplier: x3

Hyperdrive Backup: x16

Nav Computer: Yes

Space: 4

Atmosphere: 460; 740 kmh

Hull: 4D

Shields: 1D

Sensors:

Passive: 10/0D

Scan: 25/1D

Search: 40/2D

Focus: 2/3D

Weapons:

Double Laser Cannon

Fire Arc: Turret

Crew: 1

Scale: Starfighter

Skill: Starship gunnery

Fire Control: 1D

Space Range: 1-3/12/25

YT-1100

FREIGHTER TRANSPORT

Craft: Corellian Engineering Corporation YT-1100
Transports

Type: Freighter transport

Era: Rebellion

Affiliation: General

Source: Arbitrary / Random-Keith Kilburn

Scale: Starfighter

Length: 44 m

Crew: 1 pilot (1 can coordinate, +15 for 1 pilot)
and gunner.

Passengers: 7

Cargo Capacity: 100 metric tons

Consumables: 2 months

Cost: 100,000 (new), 30,000 (used), 15,000 (used -
Imperial Era)

Hyperdrive: x2

Hyperdrive backup: x25

Nav Computer: Yes

Maneuverability: 0D

Space Move: 4

Atmosphere: 280: 800 kmh

Hull: 4D

Shields: 0D

Sensors:

Passive: 15/0D

Scan: 30/1D

Search: 50/3D

Focus: 2/4D

Weapons:

Light laser cannon

Fire Arc: Turret

Crew: 1

Scale: Starfighter

Skill: Starship gunnery

Fire Control: 1D

Space Range: 1-3/12/25

Atmosphere Range: 100-300/1.2/2.5 km

Damage: 4D

Capsule: The Yt-1100 went into production before the more popular 1300, its design was a throwback to the Barloz freighter-line that the C.E.C. produced, combined with the compartmentalization of YT-Class ships to that date. However it failed to find its niche in the galactic spacers market due to its odd shape, hard to find parts and lack of maneuverability. These ships are often thought of collector's items or museum pieces because of the scarcity in which they are seen since the Clone Wars.

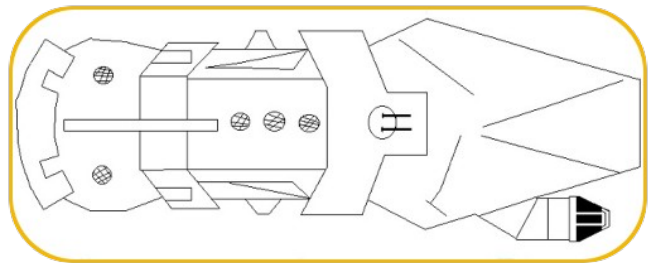

Addendum Personal- General Han Solo

The '1100' is about as ugly as a Luke-warmed Tauntaun, I know that I am supposed to be impartial and say glowing things about each of the ships, but even I got standards. This was a failed attempt by the credit-counters at the C.E.C. to 'regain a lost piece of the starship market place...' and in doing so they tried to merge the YT-line with the 'look' of the Barloz freighter-line and got this piece of work. The only time I was ever in one of these things, as a passenger, was the time that General Calrissian lost it to Commander Wayne of the Mutt Squad in a Sabacc game. Lando wasn't nearly as saddened to see it go as Commander Wayne was to win it. Oh and remember what I said about Permecrete bricks earlier? It still applies here.

YT-1150

MEDIUM TRANSPORT

Craft: Corellian Engineering Corporation YT-1150
Medium Transport

Type: Space transport

Era: Old Republic

Affiliation: General

Source: Converted-Star Wars Gamer 8

Scale: Starfighter

Length: 31.2 meters

Skill: Space transports: YT-1150

Crew: 1

Crew Skill: Varies

Passengers: 6

Cargo Capacity: 95 metric tons

Consumables: 1 month

Cost: 74,000 (new), 15,000 (used)

Hyperdrive Multiplier: x2

Hyperdrive Backup: x8

Maneuverability: 1D

Space: 4

Atmosphere: 280; 800 kmh

Hull: 3D

Shields: 1D

Sensors:

Passive: 15/1D

Scan: 40/1D+2

Search: 80/2D+1

Focus: 2/3D+1

Weapons:

2 Laser Cannons (fire-linked)

Fire Arc: Front

Crew: 1

Scale: Starfighter

Skill: Starship gunnery

Fire Control: 2D

Space Range: 1-10/20/30

Atmosphere Range: 100-1/2/3 km

Damage: 4D

Capsule: The YT-1150 Medium Transport, like the

YT-1100 is an attempt to recapture an early model of transport from the Corellian Engineering Corporation (The Barloz...) that varies greatly in design from the general concept of the later ships in the YT series of transports. Slender and long, this ship looks like a loaf of bread sliced lengthwise along each side; essentially, a long, slender center section with two engine nacelles on either side providing thrust. The ship saw a good amount of use during the days of the Galactic Republic and, as like most C.E.C. designs, it is easily modified. Almost nothing in the ship's design, save for a few core systems, is unalterable, and smugglers, pirates, merchants, and other spacefaring entrepreneurs have taken advantage of this and turned their ships into a personalized transports that suit

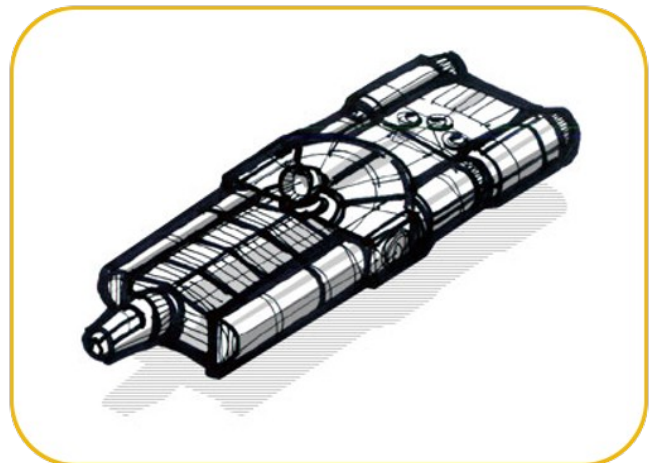

their needs perfectly.

Addendum Personal- General Han Solo

First thing, first... This is another failed attempt by the credit-counters at the C.E.C. to regain that lost market niche they are so desperately attempting to find, that is to say those who still fly and are for whom the Barloz is the end all, beat all of space freighters. I can tell you with a fair amount of certainty that no self-respecting pirate would ever use this ship as anything other than perhaps a target to lure in other, weaker pirates. Spacefaring entrepreneurs, who could afford to buy a ship outright, would be flying something with more style like a '3000' or a 'Minstrel-class' yacht, not one of these heaps.

YT-1200

LIGHT FREIGHTER

Craft: Corellian Engineering Corporation YT-1200 Transport

Type: Light Freighter

Era: Rise of the Empire

Affiliation: General

Source: Converted-Star Wars Gamer Issue 1

Scale: Starfighter

Length: 28 meters

Skill: Space transports: YT-1200

Crew: 2

Crew Skill: Varies widely

Passengers: 6

Cargo Capacity: 100 metric tons

Consumables: 2 months

Cost: 20,000 (used)

Hyperdrive Multiplier: x2

Hyperdrive Backup: x16

Nav Computer: Yes

Maneuverability: 1D

Space: 3

Atmosphere: 260; 750 kmh

Hull: 4D

Shields: 1D

Sensors:

Passive: 10/0D

Scan: 25/1D

Search: 40/2D

Focus: 2/3D

Weapons:

Laser Cannon

Fire Arc: Turret

Crew: 1

Scale: Starfighter

Skill: Starship gunnery

Fire Control: 1D

Space Range: 1-3/12/25

Atmosphere Range: 100-300/1.2/2.5 km

Damage: 4D

Capsule: The YT-1200 light freighter was a Corellian Engineering Corporation YT series freighter that served as the basis for Nova-Drive's license-built 3-Z light freighter. They had tubular, elongated cockpits and rounded hulls. Each vessel was 28 meters long. The YT-1200, along with the YT-1210 light freighter, was released after the YT-1000. Customers preferred the older YT-1000 freighters, and once the YT-1300 light freighter was released, sales of the YT-1200 disappeared. C.E.C. later took the existing YT-1200s and modified them into the YT-1250 freighter.

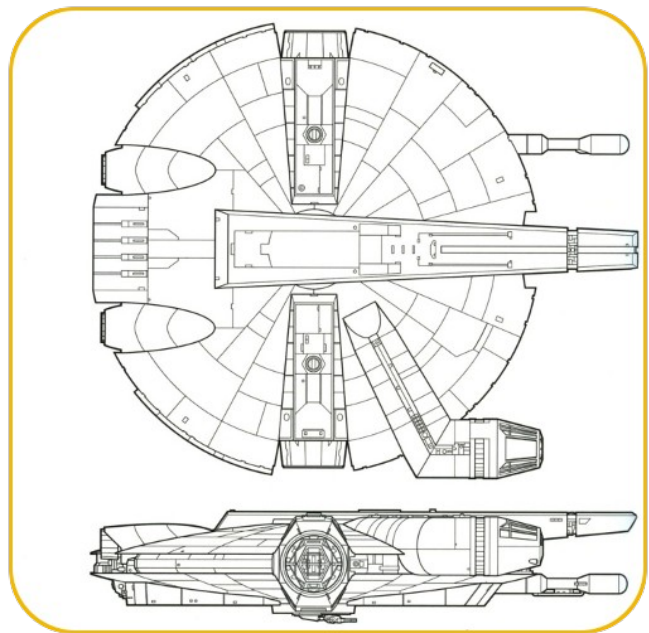

Addendum Personal- General Han Solo

Not much can be said about the '1200' other than when the C.E.C. got stuck with the entire line after poor sales they refurbished it into later models in an attempt to regain their lost finances. I suppose to be fair I should mention that the C.E.C. redesigned their patented Bi-Engine configuration and slapped a long sensor boom on the thing in an attempt to give it a new and exciting look. I can't tell you the number of times I have heard spacers complain about that thing jutting out into their field of vision and I won't mention how many times I've heard someone say "...and then I scrapped that sensor boom..."

YT-1210

LIGHT FREIGHTER

Craft: Corellian Engineering Corporation YT-1210 Transport

Type: Light freighter

Era: Rise of the Empire

Affiliation: General

Source: Official-Pirates & Privateers (pages 60-61)

Scale: Starfighter

Length: 28 meters

Skill: Space transports: YT-1210

Crew: 2

Crew Skill: Varies widely

Passengers: 4

Cargo Capacity: 100 metric tons

Consumables: 2 months

Cost: 20,000 (used)

Hyperdrive Multiplier: x2

Hyperdrive Backup: x16

Nav Computer: Yes

Maneuverability: 1D

Space: 4

Atmosphere: 280; 800 kmh

Hull: 4D

Shields: 1D

Sensors:

Passive: 10/0D

Scan: 25/1D

Search: 40/2D

Focus: 2/3D

Weapons:

Laser Cannon

Fire Arc: Turret

Crew: 1

Scale: Starfighter

Skill: Starship gunnery

Fire Control: 1D

Space Range: 1-3/12/25

Atmosphere Range: 100-300/1.2/2.5 km

Damage: 4D

Capsule: Some features of the YT-1210 would be the basis of the YT-1300 light freighter. The ship had the familiar saucer-shaped hull of the YT-1300, but lacked the forward cargo loading mandibles that gave that ship its familiar outline. The YT-1210 was 28 meters in length, and the standard crew consisted of a pilot and a gunner. The stock YT-1210 could carry up to 100 metric tons of cargo, and was armed with a single laser cannon. The ship had a small cabin for the captain, and it came equipped with a small refresher station. Unfortunately, once sales of the YT-1300 took off at some point before 33 BBY, the highly capable YT-1210 freighter had a shortened production run. The YT-1210 was not a poor design, but it was not on par with the YT-1300.

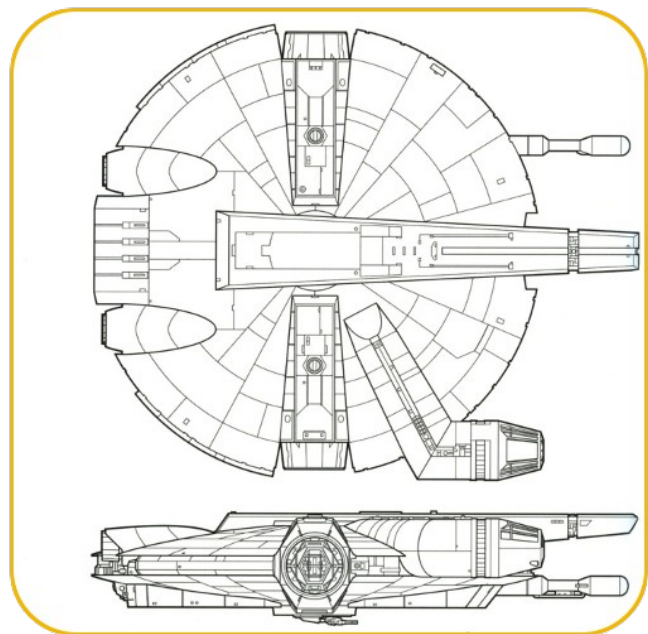

Addendum Personal- General Han Solo

If you read what I said about the '1200', then you can apply it to the '1210' as it is the same ship only with this version they installed the tri-engine configuration instead of the bi-engine. Oh and they gave the captain his own quarters and personal refresher, in the event that the captain didn't want to have to share with the rest of the crew and if you've ever been on a long ride with a Wookie that might not be such a bad design idea....

YT-1250

TRANSPORT

Craft: Corellian Engineering Corporation YT-1250 Transport

Type: Light Freighter

Era: Rise of the Empire

Affiliation: General

Source: Converted-Star Wars Gamer Issue 1, Scum and Villainy pg. 64-65

Scale: Starfighter

Length: 32.35 meters

Skill: Space transports: YT-1250

Crew: 2

Crew Skill: Varies widely

Passengers: 5

Cargo Capacity: 80 metric tons

Consumables: 3 months

Cost: 120,000 credits (30,000 used)

Hyperdrive Multiplier: x2

Hyperdrive Backup: x16

Nav Computer: Yes

Maneuverability: 1D

Space: 5

Atmosphere: 280; 800 kmh

Hull: 4D

Shields: 1D+1

Sensors:

Passive: 10/0D

Scan: 25/1D

Search: 40/2D

Focus: 2/3D

Weapons:

Laser Cannon

Fire Arc: Turret

Crew: 1

Scale: Starfighter

Skill: Starship gunnery

Fire Control: 2D

Space Range: 1-3/12/25

Atmosphere Range: 100-300/1.2/2.5 km

Damage: 4D+1

Capsule: The YT-1250 had 20% less cargo capacity than

the YT-1200, but it made up for that by having stronger engines, weapons, and a basic set of shields. It wasn't as highly upgradeable as most YT-series freighters, but it was still able to be modified to suit the user's needs. Since the YT-1250 was upgraded and reinforced, it was marketed as suitable for light defense duties, cargo transporting in hazardous areas, and being used as an armed escort for freighter convoys. The YT-1250 was an unusual model for C.E.C., since it wasn't a new design. With the release of the YT-1300, C.E.C. found itself with a huge back stock of YT-1200s and YT-1210s. In an effort to sell these ships, they redesigned the older ships and sold them as a "new" design. Sales remained sluggish but C.E.C. was finally able to sell the whole line off to various small systems and militant trade guilds.

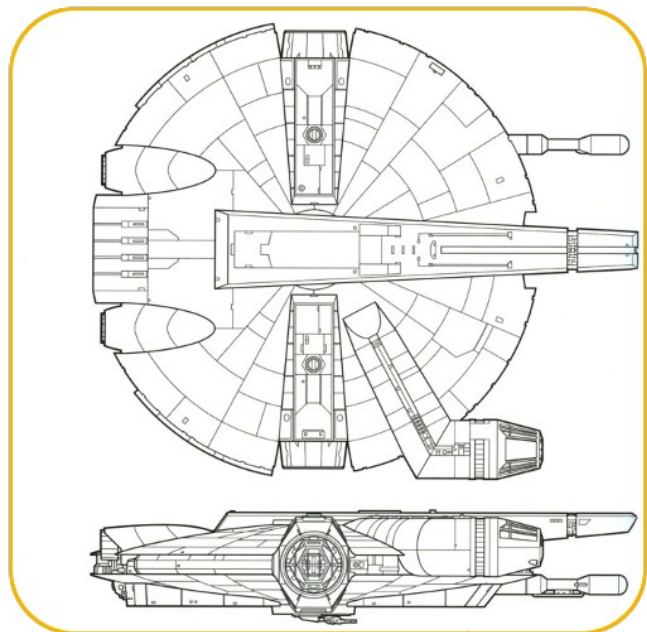

Addendum Personal- General Han Solo

Let's see here, less cargo space than the '1200' and they added a bigger tri-engine configuration, a better weapon system and some shields. The same thing that any self-respecting smuggler or free trader could have done on his own, the problem with this model is that once they started hardwiring in new tech, the ability to compartmentalize and reconfigure got locked out because the interior became solid weld points. For the record, while the Bi and Tri-engine configuration is nice and a solid piece of craftsmanship, if they break down you're doing two or three times the work getting back up and running...

YT-1300

TRANSPORT

Craft: Corellian Engineering Corp. YT-1300 Transport

Type: Freighter transport

Era: Rise of the Empire

Affiliation: General

Source: Official-Core Rulebook (page 254)

Scale: Starfighter

Length: 26.7 meters

Skill: Space transports: YT-1300

Crew: 1 (1 can coordinate), gunners: 1

Crew Skill: Varies widely

Passengers: 6; 9 (YT-1300p); None (YT-1300f)

Cargo Capacity: 100 metric tons; 50 (YT-1300p); 150 (YT-1300f)

Consumables: 2 months

Cost: 100,000 (new), 25,000 (used)

Hyperdrive Multiplier: x2

Hyperdrive Backup: x12

Nav Computer: Yes

Space: 4

Atmosphere: 480; 800 kmh

Hull: 4D

Sensors:

Passive: 10/0D

Scan: 25/1D

Search: 40/2D

Focus: 2/3D

Weapons:

Laser Cannon

Fire Arc: Turret

Crew: 1

Scale: Starfighter

Skill: Starship gunnery

Fire Control: 2D

Space Range: 1-3/12/25

Atmosphere Range: 100-300/1.2/2.5 km

Damage: 4D

Capsule: Conceived by a panel of C.E.C. shipbuilding experts with help from Narro Siemar, the YT series went on to become one of the most popular space transport hulls ever produced, revolutionizing the interstellar shipping industry with its unparalleled application of modular design. Whole sections could be mass-produced and arranged into new configurations as needed without extensive retooling. This saved C.E.C. enormous amounts of credits by allowing the starships to be brought to market at extremely competitive prices. The YT-1300 model exemplified this concept with a circular main corridor and modular compartments that could be mounted around it, all radiating outwards from a central core inside a saucer-shaped hull making for both a convenient and economic design. It was considered an equivalent of its time to the Galactic Republic Barloz cargo freighter. To date this has been the most successful C.E.C. produced freighter of all time and there continues to be more of these ships in service than any others.



Addendum Personal- General Han Solo

The first time I laid eyes on a '1300' I knew I had fallen in love, a simple design that belays all the elegance and simplicity that the C.E.C. can muster all into one fantastic design. Easy to modify this design is almost perfect for any first time spacer, some wet behind the ears farm-boy or just plain youngling out in his dad's ship to handle. In my opinion with this design the C.E.C. made the perfect ship and for that reason, this is why you see so many of them still around today. Free-traders, pirates and smugglers a like love these ships and will beg, borrow or steal to get their hands on one...

YT-1300

FLEET SUPPORT FREIGHTER

Craft: Corellian Engineering Corporation YT-1300 (Modified)

Type: Fleet Support Freighter

Scale: Starfighter

Length: 35 meters

Skill: Space Transports: YT-1300

Crew: 2 (1 @ +10) & 2 gunners)

Crew Skill: Astrogation 3D, Space Transports 4D, Starship Gunnery 4D, Starship Shields 4D+2, Starship Sensors 4D

Passengers: 6

Cargo Capacity: 80 metric tons

Consumables: 2 months

Hyperdrive Multiplier: x2

Hyperdrive Backup: x12

Nav Computer: Yes

Maneuverability: 1D

Space: 4

Atmosphere: 480; 800 kph

Hull: 4D

Shields: 2D

Sensors:

Passive: 20/1D

Scan: 30/2D

Search: 50/3D

Focus: 2/4D

Weapons:

2 Dual Laser Cannon (Fire Separately)

Fire Arc: Turret (1 top, 1 bottom)

Crew: 1 each

Scale: Starfighter

Skill: Starship Gunnery

Fire Control: 2D

Space Range: 1-3/12/25

Atmosphere Range: 100-300/1.2/2.5 km

Damage: 5D

Tractor Beam Projector

Fire Arc: Turret

Crew: 1 (pilot or co-pilot)

Scale: Starfighter

Skill: Starship Gunnery

Fire Control: 2D

Space Range: 1-2/5/10

Atmosphere Range: 100-200/500/1 km

Strength: 4D

Special Equipment:

Minehunting Sensor

Effect: +1D to Sensors to Detect & Identify mines in space.

Search & Rescue Sensor

Effect: +1D to Sensors to Detect & Identify living beings in space.

In-Flight Refueling Pod

Effect: Allows the freighter to recharge the consumables of star-fighters and similar craft while in flight. Can recharge one light freighter-sized vessel at a time or two star-fighter-sized vessels simultaneously.

Capsule: This pod is mounted on the ship's underside, forward of the ventral gun turret. It features a pair of short-ranged tractor beams that lock onto other ships to bring them in close to the freighter. EVA droids then haul extendable transfer hoses across and connect them to perform the transfer. Transfer times for star-fighters are generally 1 minute for every day of consumables.

Forward Launch Bay

Capsule: The space between the bow mandibles on the YT-1300 serves as a forward loading bay that connects to the ship's forward cargo hold. Alliance engineers have modified the cargo loading grapples to serve as a launch system for a variety of different types of equipment, including sensor probes, mine disposal vehicles, EVA droids, and even (rarely) concussion missiles.

Capsule: Standard Alliance star-fighter wings are generally assigned a pair of stock light freighters as utility support craft. However, as the saying goes, there

is no such thing as a stock light freighter. As with nearly all light freighters, the ships are quickly modified and adapted to suit their operator's needs, and the freighters of the Alliance's Starfighter Command are no exception. The YT-1300 Fleet Support Freighter has been modified in a variety of little ways to provide added support services to both Alliance Fleet Taskforces and Alliance Starfighter Wings. Among its upgrades are improved weapons, sensors and shields, along with in-flight refueling, minesweeping and search & rescue equipment. The result is a versatile little ship that can serve as a scout, or in a variety of different support roles in addition to its standard role as a light freighter.

Addendum Personal- General Han Solo

Y'see what I mean? Even Alliance command loves to get their hands on these, they were in heavy use during the war and even in the clean-up that came after the Alliance were still designing and redesigning ways to make these ships work more efficiently.

MILLENNIUM FALCON MODIFIED FREIGHTER

Craft: Modified Corellian Engineering Corporation YT-1300 Transport

Type: Modified light freighter

Era: Rise of the Empire

Affiliation: Han Solo (smuggler/rebel)

Source: Official...

Scale: Starfighter

Length: 26.7 meters

Skill: Space transports: YT-1300 transport

Crew: 2, gunners: 2, skeleton: 1/+5

Crew Skill: See Han Solo and Chewbacca in any game listing for this information.

Passengers: 6

Cargo Capacity: 100 metric tons

Consumables: 2 months

Cost: Not for sale

Hyperdrive Multiplier: x1/2

Hyperdrive Backup: x10

Nav Computer: Yes

Maneuverability: 2D

Space: 8

Atmosphere: 365; 1,050 kmh

Hull: 6D

Shields: 3D

Sensors:

Passive: 30/1D

Scan: 60/2D

Search: 75/3D

Focus: 4/4D

Weapons:

2 Quad Laser Cannons

Fire Arc: Turret

Crew: 1

Scale: Starfighter

Skill: Starship gunnery

Fire Control: 3D

Space Range: 1-3/12-25

Atmosphere Range: 100-300/1.2/2.5 km

Damage: 6D

2 Concussion Missile Tubes (fire-linked)

Fire Arc: Front

Crew: 1

Scale: Starfighter

Skill: Starship gunnery

Fire Control: 3D

Space Range: 1/3/7

Atmosphere Range: 50-100/300/700

Damage: 9D

Blaster Cannon (retractable)

Fire Arc: Turret

Crew: 1

Scale: Speeder

Skill: Vehicle blasters

Fire Control: 4D (fired from cockpit)

Atmosphere Range: 1-50/100/250

Damage: 3D+2

Addendum Personal- General Han Solo

I figured while I was talking about the '1300' I would take the time to talk about the 'Falcon' too, a lot of hard work and love went into make her what she is today and while I won't flaunt all the modifications I've done to her over the years here, I will mention the ones that got used during the war. Whether your partner is stripping the ship down to fix it while you're trying to make good an escape, or if you're holding the hand of a trembling princess while trying to fix the Hyperdrive or if your good buddy who lost the ship to you to begin with calls her 'the fastest hunk of junkie in the galaxy', if you treat your ship right, she'll be there for you through thick and thin...

Addendum Personal- General Lando Calrissian

If anyone else, other than maybe Chewbacca had something to say about the 'Falcon', it would be me and I am glad to finally be able to address the matter in a public setting, such as it is. First let me say that I am honored to have been one of a few owners of this fantastic ship, it saw me through some of my earlier escapades and when I lost her to Han in a game of Sabacc... Well I won't lie about it, it hurt. I've always been a materialistic person and to lose a prize like the 'Falcon' to someone like Han Solo, well it stung my pride. But I have to be honest with myself and you about this matter and I'm fairly certain that I've never told him this either, when I got a little older and had the chance to see her again for the first time in many years on that fateful day during the war I realized that the better man had won that Sabacc game and that the 'Falcon' was in better hands than I could ever have provided for her.

YT-1350

TRANSPORT

Craft: Corellian Engineering Corp. YT-1350 Transport

Type: Transports

Era: Rise of the Empire

Affiliation: General

Source: Arbitrary / Random- originates from RPGamer.org and a model project.

Scale: Starfighter

Length: 26.7 meters

Skill: Space transports: YT-1350

Crew: 1 (1 can coordinate), gunners: 1

Crew Skill: Varies widely

Passengers: 3

Cargo Capacity: 50 metric tons

Consumables: 2 months

Cost: 80,000 (new), 20,000 (used)

Hyperdrive Multiplier: x2

Hyperdrive Backup: x12

Nav Computer: Yes

Space: 5

Atmosphere: 500; 850 kmh

Hull: 4D

Sensors:

Passive: 10/0D

Scan: 25/1D

Search: 40/2D

Focus: 2/3D

Weapons:

Concussion Missile Launcher

Fire Arc: front

Crew: 1

Scale: Starfighter

Skill: Starship gunnery

Fire Control: 2D

Space Range: 1/3/7

Atmosphere Range: 100/300/700

Ammo: 10 missiles

Damage: 7D

Capsule: The YT-1350 is a cut down version of the popular YT-1300, basically a halved model of that design sacrificing much of the cargo space and creature comforts that go with typical Yt-1300 configurations. While one would think that the lighter hull allows a faster drive result, the truth is that half the engine was sacrificed as well, along with the capability of putting in bottom and topside turrets. The designers intended to make them an efficient and deadly combat vessel, not as weak as a standard transport, however they failed from the standpoint that it has no shields and is armed with a missile rack that should it take a direct hit would only succeed in ripping the ship in half.



Addendum Personal- General Han Solo

Chewie and I looked the holopic over and can't figure out how this thing could fly, much less land. Neither one of us has ever seen anything like it...

YT-1566

TRANSPORT

Craft: Corellian Engineering Corp. YT-1566 Transport

Type: Transport

Era: Rise of the Empire

Affiliation: General

Source: Arbitrary / Random-appears to originate with RPGgamer.org

Scale: Starfighter

Length: 32.2 meters

Skill: Space transports: YT-1566 Space Transport

Crew: 2 Skeleton: 1/+5

Crew Skill: Varies widely

Passengers: 6

Cargo Capacity: 110 metric tons

Consumables: 5 months

Cost: 170,000 (new), 32,000 (used)

Hyperdrive Multiplier: x2

Hyperdrive Backup: None

Nav Computer: Yes

Space: 5

Atmosphere: 500; 700 kmh

Hull: 4D

Shields: 1D

Sensors:

Passive: 15/0D

Scan: 30/1D

Search: 45/2D

Focus: 2/3D

Weapons:

Twin Laser Cannon (fire-linked)

Fire Arc: front

Crew: 1

Scale: Starfighter

Skill: Starship gunnery

Fire Control: 2D

Space Range: 1-3/12/25

Atmosphere Range: 100-300/1.2/2.5 km

Damage: 5D

Capsule: Designed with a strong Ion sub-light Drive to be upgraded for more weapons and additional upgrade modifications the YT-1566 Transport is perfect at the edge of standard galactic law.



Addendum Personal- Chewbacca, life-partner of General Han Solo...

<A long series of Wookie sounds are made into the recorder>

Addendum Personal- General Han Solo

That's tellin' 'em Chewie and I gotta agree, it looks like a holopic of a blaster on its side...

YT-1600

TRANSPORT

Craft: Corellian Engineering Corp. YT-1600 Transport

Type: Transport

Era: New Republic

Affiliation: General

Source: Source: Arbitrary / Random-Appears to originate from RPGgamer.org

Scale: Starfighter

Length: 29.8 meters

Skill: Space transports: YT-1600

Crew: 1 (1 can coordinate), gunners: 1

Crew Skill: Varies widely

Passengers: 5

Cargo Capacity: 190 metric tons

Consumables: 4 months

Cost: 160,000 (new), 30,000 (used)

Hyperdrive Multiplier: x2

Hyperdrive Backup: None

Nav Computer: Yes

Space: 4

Atmosphere: 450; 800 kmh

Hull: 4D

Sensors:

Passive: 15/0D

Scan: 30/1D

Search: 45/2D

Focus: 2/3D

Weapons:

Laser Cannon

Fire Arc: front

Crew: 1

Scale: Starfighter

Skill: Starship gunnery

Fire Control: 1D

Space Range: 1-3/12/25

Atmosphere Range: 100-300/1.2/2.5 km

Damage: 3D

Capsule: The YT-1600 is a slightly larger C.E.C. transport vessel, providing a fairly roomy cargo hold, which makes this vessel ideal for modification. Slower than some of the Corellian transports available, the YT-1600 has a central cockpit offering a good view forwards, as well as a single laser cannon mounted alongside the cockpit for forward firing. The YT-1600 has sold well in the decades since it was released, and although due for retirement from production soon.



Addendum Personal- General Han Solo

This one I have seen before and let me give you a little insight into the mindset of the C.E.C. and a little known fact about the '1600'. This was the C.E.C.'s one attempt to placate the Imperials and was offered originally as an alternative to the commonly used Lambda-Class shuttles. I don't know if the story is true or not, but I was told that Vader choked the life from the representative that offered it to him. Hence the ship went out on the market to recoup design costs.

YT-1760

LIGHT FREIGHTER

Craft: Modified YT-1760
Type: Light Freighter
Era: Rise of the Empire
Affiliation: General
Source: Converted-Star Wars Gamer 2
Scale: Starfighter
Length: 20 meters
Skill: Space Transports: YT-1760
Crew: 1 or 2
Crew Skill: Varies
Passengers: 8
Cargo Capacity: 10 metric tons
Consumables: 2 months
Cost: 80,000 (new), 20,000 (used)
Hyperdrive Multiplier: x1
Hyperdrive Back-Up: x15
Nav Computer: Yes
Maneuverability: 1D
Space: 7
Atmosphere: 365; 1000 kmh
Hull: 3D
Shields: 0
Sensors:
 Passive: 10/0D
 Scan: 25/1D
 Search: 40/2D
 Focus: 2/3D
Weapons:
 None

Capsule: Released around the time of the Battle of Naboo, the YT-1760 was part of the popular YT series. Though it succeeded in improving on the slower sub-light and Hyperdrive speeds of older models, it did so at the cost of cargo capacity and defense capability. The YT-1760 was released with no weapons or shields, and

its hull was less sturdy than many of its predecessors. The larger drive systems had already reduced the cargo capacity, but most of the owners decided to trade cargo room for shield generators. Fortunately, the YT-1760 shared the easy modification of other YT ships, and it was also common for owners to add better weaponry. Some captains chose to replace the passenger quarters with staterooms, though this reduced the passenger capacity to four beings. Their high maintenance costs caused most YT-1760s to be scrapped by the time of the Galactic Civil War, but some operators still preferred them to newer ships.



Addendum Personal- General Han Solo

If it was the intention of the C.E.C. to make a faster cargo vessel then I think they failed miserably as the 1760 only have as ten ton capacity and the fact that you're limited on space means you're not making much money...Worse yet there is nothing that can be done to improve that, short of external cargo pods which reduce maneuverability and speed...

YT-1900

TRANSPORT

Craft: Corellian Engineering Corporation YT-1900 Transport, Patrol Bomber-B and Ship Yard tender-C variants.

Type: C.E.C. YT-1900 Space Transport

Era: Rebellion

Affiliation: General

Source: Arbitrary / Random-Marcus Starkiller, crmcneill and Zarn

Scale: Starfighter

Length: 26.2m

Skill: Space Transports - YT-1900

Crew: 1 (Gunners: 1)

Crew Skill: varies

Passengers: 2

Consumables: 2 Months

Cargo Capacity: 15 Tons. 1900-B and C: 5 tons

Cost: 110,000 (new); 27,000 (used)

Hyperdrive Multiplier: x2

Hyperdrive Backup: x12

Nav Computer: Yes

Space: 6 (1900-B: 10, 1900-C: 5*)

Atmosphere: 700; 1200 kmh

Maneuverability: 2D

Hull: 4D

Shields: 0 (1900-B has 2D)

Sensors:

Passive: 15/0D

Scan: 30/1D

Search: 50/2D

Focus: 2/3D

Weapons:

1900-A or B

Dual Laser Cannon

Fire Arc: Turret (B-Rear)

Crew: 1

Skill: Starship Gunnery

Fire Control: 3D

Space Range: 1-3/12/25

Atmosphere Range: 100-300/1.2/2.5 km

Damage: 5D

1900-B (Only)

2 Proton Torpedo Launchers

Fire Arc: Front

Crew: 1 (pilot or copilot)

Scale: Starfighter

Skill: Starship Gunnery

Fire Control: 3D

Space Range: 1/3/7

Atmosphere Range: 50-100/300/700

Ammo: 36 torpedoes

Damage: 9D

1900-C

Tractor beam

Fire Arc: turret (ventral)

Crew: 1

Scale: Starfighter

Skill: Starship Gunnery

Fire Control: 2D

Space Range: 1-3

Atmosphere Range: 100-300

Damage: None**

Maghook launcher

Fire Arc: rear

Crew: 1 *Scale:* Starfighter

Skill: Starship Gunnery

Fire Control: 2D

Space Range: 1

Atmosphere Range: 100

Damage: None***

* Though the ship has but 5 in Space rating, it has extremely powerful engines for its size

** The tractor beam allows moving objects of a rating up to 10 Metric Tons

*** The maghook allows the tug to change an object's Space rating by 1 (for a maximum of 5, minimum of 0) if

YT VESSELS

the object masses less than 5 000 Metric Tons. Several tugs can act in concert to move larger objects than 5 kMT.

Capsule: The YT-1900 is a later model from C.E.C., and is heavily based on the hugely successful YT-1300, with an off-center cockpit, cargo loading arms, and many other features familiar to those who have flown the YT-1300. Slightly bulkier, but with more powerful engines, the YT-1900 can carry larger cargoes, which are loaded through a forward mounted cargo hatch, leaving the lower ramps free for use by crew and passengers. However should the front hatch not be available, or useable, then the lower ramps can still be used as in other older designs. While opinions have been mainly positive about the YT-1900, the only major complaint has been about the turrets placement, since its field of fire is somewhat blocked by the large engine housings that run along the top of the vessel, but as with all turret placements the fire of fire always depends on good interaction between the pilot and gunner. As with previous YT series ships, the turret can be locked into a forwards firing position, and fired by the pilot if he is flying the ship solo. The YT-1900 has sold in modest numbers and failed to be as big a success as the other YT freighters.

Two variants were made of this model (One a combat variant used for light military use, border patrol and disputes and the other a tug-ship used for ship yards primarily in the assisting disabled ships to their final docking place...) and while both had adequate numbers when it came to sales, neither caught on as well as the C.E.C. had hoped and were eventually discontinued.



Addendum Personal- General Han Solo

I asked around and no one I know has ever seen a '1900, strangest lookin' ship I've ever seen...

YT-1930 LIGHT FREIGHTER

Craft: Corellian Engineering Corporation YT-1930 Light Freighter

Type: Stock light freighter

Era: Rebellion

Affiliation: General

Source: Official-Wretched hive of scum and villainy (pg. 98)

Scale: Starfighter

Length: 35 meters

Skill: Space transports: YT-1930

Crew: 2

Crew Skill: Varies widely

Passengers: 6

Cargo Capacity: 200 metric tons

Consumables: 4 months

Cost: 135,000 credits (new), 45,000 credits (used)

Hyperdrive Multiplier: x2

Hyperdrive Backup: x12

Nav Computer: Yes

Maneuverability: 1D+2

Space: 6

Atmosphere: 280; 800 kmh

Hull: 4D

Shields: 2D

Sensors:

Passive: 10/0D

Scan: 25/1D

Search: 40/2D

Focus: 2/3D

Weapons:

Twin Heavy Laser Cannon

Fire Arc: Turret

Crew: 1 (co-pilot)

Scale: Starfighter

Skill: Starship gunnery

Fire Control: 2D

Space Range: 1-3/12/25

Atmosphere: 100-300/1.2/2.5 km

Damage: 4D

Capsule: The YT-1930 was a series light freighter that was released by the C.E.C. shortly before the Battle of Yavin. The design of the YT-1930 was a variant on the successful YT-1300 light freighter, but placed the cockpit along the center line of the ship, and added two wedge-shaped cargo areas at the rear to double the cargo capacity of its predecessor. Most came with a single laser cannon turret. Though some considered it to be the pinnacle of the YT series, the YT-1930 never gained the following the older freighter design had.

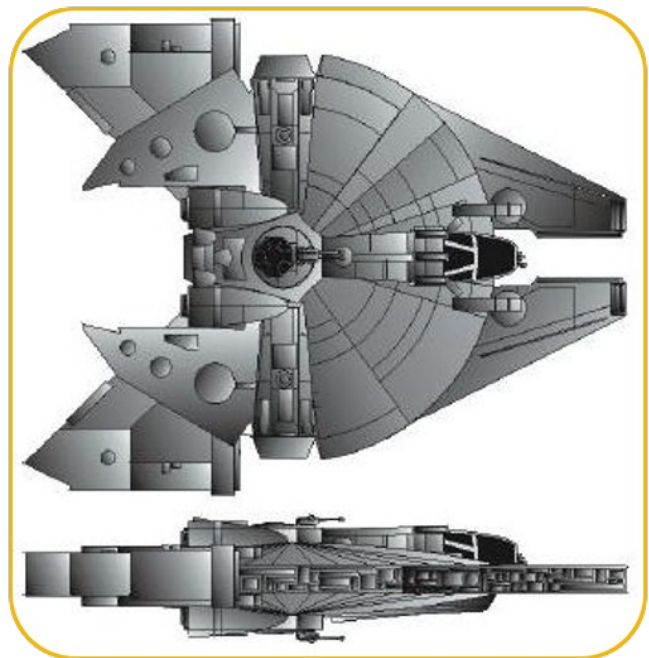

Addendum Personal- General Han Solo

For the price tag, this is a decent ship. Good cargo space with plenty of extras...

YT-1950

TRANSPORT

Craft: Corellian Engineering Corporation YT-1950

Space Transport

Type: Space Transport

Era: Rebellion

Affiliation: General

Source: Arbitrary/Random-Appears to originate from RPPGAMER.org and a fan-based model.

Scale: Starfighter

Length: 29.1m

Skill: Space Transports - YT-1950

Crew: 1 + 1 Gunner

Crew Skill: varies

Passengers: 7

Consumables: 8 Months

Cargo Capacity: 160 Tons

Cost: 105,000 (new); 26,000 (used)

Hyperdrive Multiplier: x2

Hyperdrive Backup: x12

Nav Computer: Yes

Space: 5

Atmosphere: 650; 950 kmh

Maneuverability: 1D

Hull: 4D+2

Shields: 1D

Sensors:

Passive: 15/0D

Scan: 30/1D

Search: 50/2D

Focus: 2/3D

Weapons:

Laser Cannon

Fire Arc: Turret

Scale: Starfighter

Skill: Starship Gunnery

Fire Control: 1D

Space Range: 1-3/15/25

Atmosphere Range: 100-300/1.5/2.5 km

Damage: 4D

Capsule: The YT-1950 is a slightly larger variant of the YT-1930 Corellian Transport vessel, capable of carrying more cargo than the extremely successful YT-1300; the design is similar to the YT-2000 design which followed it. The ship has a central cockpit offering a better overall field of vision to the side cockpit of the YT-1300, but the cargo mandibles block vision to the sides something that was rectified with the extended neck of the YT-2000. YT-1950's are still sold, although the line is close to retirement, and many thousands of these vessels can be seen across the entire galaxy.



Addendum Personal- General Han Solo

Eight months of food, and seven passengers you'd think the C.E.C. expects the crew to live on the '1930, lemme tell you, when Chewie and I went to Cloud City we didn't live in the Falcon...

YT-2000

TRANSPORT

Atmosphere Range: 100-300/1.2/2.5 km

Damage: 5D

** Can be fixed to forward to be fired by the pilot at 1D.)*

Craft: Corellian Engineering Corporation YT-2000 Transport

Affiliation: General

Era: Rebellion

Source: Converted-Starships of the galaxy -Saga edition (pg. 154)

Type: Light Freighter

Scale: Starfighter

Length: 29.4 m

Skill: Space Transports: YT-2000

Crew: 1 or 2 (Can Co-ordinate)

Passengers: 7

Cargo Capacity: 115 Tons

Consumables: 3 Months

Cost: 150,000 Credits-new, 45,000-used

Hyperdrive Multiplier: x2

Hyperdrive Backup: x12

Nav Computer: Yes

Maneuverability: 1D+2

Space: 4

Atmosphere: 330; 950 kmh

Hull: 5D

Shields: 2D

Sensors:

Passive: 15/0D

Scan: 35/1D

Search: 60/2D

Focus: 3/3D

Weapons:

2 Quad Laser Cannon (Dorsal and Ventral)

Fire Arc: 1 Dorsal Turret, 1 ventral turret

Crew: 1 or Pilot

Scale: Starfighter

Skill: Starship Gunnery

*Fire Control: 2D **

Space Range: 1-3/12/25

Capsule: The YT-2000 combined the 1300's successful saucer-like design with the 1930's symmetrical theme, including the centralized cockpit. The standard cockpit design of the YT-2000 deviated from the pilot and co-pilot sitting side by side, as in previous models. Instead, the pilot sat in front while the co-pilot was situated behind the pilot, with no room for any other people in the cockpit. Due to the turbulent times in which the ship was designed and produced, the YT-2000 boasted heavier standard shields and weapons (two dual laser turrets) than any of its predecessors. The armament and shields, coupled with its speed and maneuverability, caused many Imperial officials to view the YT-2000 with suspicion. The YT-2000 had a limited production run. The line was discontinued so C.E.C. could push their new YT-2400 line, which had not been compromised by industrial espionage.



Addendum Personal- General Han Solo

For fifty thousand more credits you get fifteen more tons of cargo capacity, an ugly and unfriendly cockpit layout and a ship rife with problems before it ever repulsored out of the factory. Save that extra fifty thousand creds for upgrades and get you something a little older...

YT-2400

TRANSPORT

Craft: Corellian YT-2400 Transport
Type: Stock light freighter
Era: Rebellion
Affiliation: General
Source: Official-Stock Ships (pages 17-19)
Scale: Starfighter
Length: 21 meters
Skill: Space transports: YT-2400
Crew: 2, gunners: 1, skeleton: 1/+10
Crew Skill: Varies widely
Passengers: 6
Cargo Capacity: 150 metric tons
Consumables: 2 months
Cost: 130,000 (new), 32,000 (used)
Hyperdrive Multiplier: x2
Hyperdrive Backup: x12
Nav Computer: Yes
Space: 4
Atmosphere: 480; 800 kmh
Hull: 5D
Shields: 2D
Sensors:
Passive: 10/0D
Scan: 25/1D
Search: 40/2D
Focus: 2/3D
Weapons:
Laser Cannon
Fire Arc: Turret
Crew: 1
Scale: Starfighter
Skill: Starship gunnery
Fire Control: 2D
Space Range: 1-3/12/25
Atmosphere Range: 100-300/1.2/2.5 km
Damage: 4D

Capsule: The YT-2400 light freighter was a YT series light freighter produced by Corellian Engineering Corporation similar to the YT-1300. Favored by smugglers, the ship featured the YT series trademark saucer-shaped hull and starboard-mounted command pod. Like most Corellian designs, the YT-2400 was fast, tough, and endlessly modifiable. Stock YT-2400s were 21 meters in length, required two pilots, and were armed with a single laser cannon turret, although the ship was easily customized for modifications to the stock frame. Thus, the design was favored by mercenaries and smugglers, or any other being in need of a well-armed "transport".



Addendum Personal- General Han Solo

The 2400 isn't that bad of a ship and having been on the 'Outrider' a couple of times I can tell you that it handles well, has a decent layout and overall is everything that a freighter is supposed to be. New or used the 2400 is a worthy investment...

YT-2550

MEDIUM TRANSPORT

Craft: Corellian Engineering Corporation YT-2550

Medium Transport

Type: Medium freighter

Era: Rebellion

Affiliation: General

Source: Official/fan-made-The Politics of Contraband and Classic Adventures (Pg. 3 in both...) for the original, modifications suggested by HighAdmiral.de at <http://www.highadmiral.de/lssa.htm#yt-2550>

Scale: Starfighter

Length: 65.9 meters

Skill: Space Transports: YT-2550

Crew: 4, gunners: 2, skeleton: 2/+5

Crew Skill: Varies widely

Passengers: 10

Cargo Capacity: 800 metric tons

Consumables: 4 months

Cost: 220,000 credits-new, 100,000 credits-used

Hyperdrive Multiplier: x2

Hyperdrive Backup: x12

Nav Computer: Yes

Maneuverability: 1D

Space: 4

Atmosphere: 280; 800 kmh

Hull: 4D+1

Shields: 1D

Sensors:

Passive: 10/0D

Scan: 25/1D

Search: 40/2D

Focus: 2/3D

Weapons:

2 Laser Cannons

Fire Arc: Turret

Crew: 1

Scale: Starfighter

Skill: Starship gunnery

Fire Control: 2D

Space Range: 1-3/12/25

Atmosphere: 100-300/1.2/2.5 km

Damage: 4D

Capsule: The YT-2550 was a medium freighter from Corellian Engineering Corporation's YT series. YT-2550s were seen in use by smugglers shortly after the Battle of Endor. Like other YT series vessels, they could be easily modified.



Addendum Personal- General Han Solo

This one is a strange case; I've only ever seen one used by some smugglers that I met once in the Rebellion back during the war. I've heard a couple of different ratings on the cargo capacity, but have no firsthand knowledge of the ship other than a strange looking layout for a ship from the C.E.C.. From my understand the '2550 had a very limited run and was shelved in an effort to keep costs down and profits up as it didn't sell very well.

YT-3000

LIGHT TRANSPORT

Craft: Corellian Engineering Corporation YT-3000 Light Transport

Type: Stock Light Freighter

Era: Rebellion

Affiliation: General

Source: Arbitrary, Random-Appears to originate from RPPGAMER.org and this project <http://steamcommunity.com/sharedfiles/filedetails/?id=189637662>

Scale: Starfighter

Length: 31.57 meters

Skill: Space Transports: YT 3000

Crew: 1

Crew Skill: Varies Tremendously

Passengers: 8

Cargo Capacity: 150 metric tons

Consumables: 6 months

Cost: 150, 000 (new), 40, 000 (used)

Hyperdrive Multiplier: x2

Hyperdrive Backup: x15

Nav Computer: Yes

Space: 4

Maneuverability: 1D+1

Atmosphere: 280; 800 kmh

Hull: 3D

Shields: 1D+2

Sensors:

Passive: 15/1D

Scan: 40/2D

Search: 50/3D

Focus: 2/4D

Weapons:

Blaster Cannon

Fire arc: Front

Crew: 1 (pilot or gunner)

Scale: Starfighter

Skill: Starship Gunnery

Fire Control: 1D+1

Space Range: 1-3/12/25

Atmosphere Range: 100-300/1.2/2.5 km

Damage: 4D

Capsule: The YT-3000 looks like a YT-1300 but it has the cockpit on the top in the middle and a blaster cannon in between the two pointy things at the front.



Addendum Personal- General Han Solo

Y'know from reading the brief description of the '3000, someone in the market to purchase one wouldn't have much to go on and other than some modifications to the hyper drive, hull and shielding...well a smart smuggler, free trader or purchaser in general would be better off purchasing a '3500 used and saving themselves some money...

YT-3500

TRANSPORT

Craft: Corellian Engineering Corporation YT-3500
Space Transport

Type: Space transport

Era: Rebellion

Affiliation: General

Source: Arbitrary / Random-Appears to originate from RPPGAMER.org and this project
http://swfanon.wikia.com/wiki/Corellian_Courier

Scale: Starfighter

Length: 26.7m

Skill: Space Transports - YT-3500

Crew: 1 (Gunners: 1)

Crew Skill: varies

Passengers: 6

Consumables: 2 Months

Cargo Capacity: 150 Tons

Cost: 105,000 (new); 26,000 (used)

Hyperdrive Multiplier: x2

Hyperdrive Backup: x12

Nav Computer: Yes

Space: 4

Atmosphere: 480; 800 kmh

Maneuverability: 0D

Hull: 4D

Shields: 2D

Sensors:

Passive: 30/0D

Scan: 60/1D

Search: 75/2D

Focus: 4/3D

Weapons:

Laser Cannon

Fire Arc: Turret

Scale: Starfighter

Skill: Starship Gunnery

Fire Control: 2D

Space Range: 1-3/15/25

Atmosphere Range: 100-300/1.5/2.5 km

Damage: 4D

Capsule: The YT-3500 is a late series Corellian Freighter and originally designed as a fuel hauler which contains some small refinements over the earlier Corellian transports such as the YT-1300, but wasn't distinguished enough to make any huge impact on the market. The vessel has a smaller drive unit which accounts for the larger cargo capacity even though it uses only a very slightly modified YT-1300 hull, the central cockpit is also considered to be an improvement giving the pilot a better forward view from the vessel, however some have criticized the fact that it is difficult to see below the ship from the cockpits high placement, making landings sometimes difficult. The cockpits placement also blocks the space many owners use in YT-1300's for an upper gun turret, however the lower gun socket is pre-installed with a laser cannon.



Addendum Personal- General Han Solo

Here is another example of what is basically the same design being used again. Personally it looks as though the C.E.C. used the existing frame and installed slightly better equipment in order to get a bigger share of market sales.

CHAPTER 2

BULK TRANSPORTS AND YACHTS

When most people think about Bulk Freighters they think about colossal ships packed to the brim with cargo moving along at a sand crawler's pace, for the most part when it comes to capital ships that isn't an unfair assessment of the speed and grace with which they tend to operate under. It's been my general experience that bulk freighters are only good for few jobs and yachts are only good for throwin' parties and toolin' around the known galaxy showin' off how many credits you have and hobnobbing with the rich and famous.

What a lot of people don't realize or maybe even don't know is that most of the Bulk freighters that the Corellian Engineering Corporation has flyin' these days and the one yacht they put on the market were in fact designed by the same guy. A long, long time ago really not so far away the Corellian Engineering Corporation hired a Givin named Galdivar Xaw'Mel, who at the time of his employment was still a student at the Orbital Polytechnique University at Talsion at the age of nineteen. Despite the fact that he worked in the Corellian Engineering Corporation's Design Specifications Division of, his primary field of study was droid programing which lead to him being a part of the 'Nerfworks' project before it was shut down.

"Maximizing space and utilizing the most efficient engine capacity as well as factoring for fuel consumption through the new XHT-8311 fuel processing pump, the Corellian Engineering Corporation will help the Republic bring much needed supplies to all those hard to reach places in the galaxy. In doing so think of all the people that will be touched by the gift of much needed food, medical supplies and general comforts that can be shipped more efficiently and expeditiously thanks to improvements and designs that I have implemented with this new line of bulk freighters, I've begun work on a space yacht and at the next annual board meeting plan to submit new designs for a new fleet of stock light freighters as well..."

-Galdivar Xaw'Mel

No one knows for sure whatever became of Galdivar; rumor has it that he became a part of the Rebellion after the Imperials laid waste to the Orbital Polytechnique University at Talsion in what is now known as the 'Talsion student up-

rising'. I can tell you that *I* wish that he had presented whatever he was workin' on at the time to the board of directors of the Corellian Engineering Corporation's as I'm sure that it would have turned the YT-freighter class on its head... Truthfully, I've made more credits off the back of his work than most of the free traders that are out there flyin' ships right now and now that he is gone, I miss him and I ain't even a little bit sentimental except maybe where my grandchildren are involved. His work on cargo capacity to fuel consumption ratio still stands the test of time and he did the work at the tender age of nineteen while still at the academy.

Bulk freighters, despite what I said earlier, can be used for a variety of things...Smuggling, transport of goods for the common man, hauling Starfighters from one side of the galaxy to another. Piracy, rebellion strongholds and just plain getting' around from one place to another; if you want to move fast then I suggest you get a stock light freighter and learn to fly through life by the seat of your pants. If on the other hand you want to take your time getting from place to place and maybe, in the meantime, get to see some of the universe, then get you a bulk freighter and take to the space lanes learning to enjoy the pace of life that comes with it.

**Booster Terrik,
Proud owner of the Errant Venture.**

CE-2 TRANSPORT LIGHT FREIGHTER

Craft: Corellian Engineering Corporation CE-2 Transport

Type: Light freighter

Era: Rebellion

Affiliation: General

Source: Official-Pirates and Privateers-pg. 66

Scale: Starfighter

Length: 100 meters

Skill: Space transports: CE-2 transport

Crew: 2

Crew Skill: Varies widely

Passengers: 2

Cargo Capacity: 50,000 metric tons

Consumables: 2 months

Cost: 200,000 (new), 95,000 (used)

Hyperdrive Multiplier: x2

Hyperdrive Backup: x12

Nav Computer: Yes

Maneuverability: 1D

Space: 3

Atmosphere: 260; 750 kmh

Hull: 4D

Shields: 1D

Sensors:

Passive: 10/0D

Scan: 25/1D

Search: 40/2D

Focus: 2/2D+2

Capsule: An odd hybrid of a light freighter and space barge, the CE-2 is an experiment intended to use a light freighter configuration to move barge cargo pods. The result has sold decently well, and may herald a change in medium freighter design.



Addendum Personal- General Han Solo

I hadn't been on one of these since I hitched a ride from Corellia to the outer-rim when I was a teenager first learnin' to be a pilot. The thing about the CE-2 is that what you see is what you get when it comes to this freighter. It's big and bulky with lots of cargo space, during the war I knew a rebel crew that converted one into a carrier, I've met pirates that have run entire operations out of a single CE-2 and I have known free-traders who wouldn't give up their battered old ships, not for love nor credits. Despite the lack of weaponry, these freighters are a decent buy no matter what it is that you're getting up to...

CORELLIAN CR-12 BULK TRANSPORT

Type: Corellian Engineering Corporation CR-12

Bulk Transport

Type: Bulk transport

Era: Rebellion

Affiliation: General

Source: Arbitrary / Random-Homemade and appears to originate from RPGGAMER.org

Scale: Capital

Length: 145 Meters

Skill: Space Transports: Corellian Bulk Transport

Crew: 20, Skeleton Crew: 5/+10

Crew Skill: Varies widely

Passengers: 20

Cargo Capacity: 15000 Tons

Consumables: 6 Months

Cost: 2 Million (new), 0.5 Million (used)

Hyperdrive Multiplier: x2

Hyperdrive Backup: x12

Nav Computer: Yes

Maneuverability: 1D

Space: 5

Atmosphere: 300, 900 kmh

Hull: 3D

Shields: 1D

Sensors:

Passive: 40/1D

Scan: 80/2D

Search: 100/3D

Focus: 4/4D

Weapons:

None

Capsule: The Corellian CR-12 Bulk Transport is a similar vessel as the CR-90 Corvette designed and built

long before the Corvette entered production and continuing to be built until recently, however the CR-12 was designed to be a straight transport vessel with a large cargo capacity and high top speed instead of the flexible and easily modified combat vessel that the CR-90 is. As a cargo vessel the CR-12 is perfect, however owner began modifying them, adding weapons and armor making them into combat vessels, something that the designers had never intended but took into consideration for their later designs. CR-12's continue to operate across the galaxy, some modified into capital ships for pirates and other groups who operate on the edge of legality, but many more just continuing to carry cargo across the galaxy as they have for decades.



Addendum Personal- General Han Solo

Slow, dependable, unarmed and cheaply made, but with an expensive price tag...that's the C.E.C. for you.

HT-2200

MEDIUM FREIGHTER

Craft: Corellian Engineering Corporation HT-2200

Type: Medium freighter

Era: Rise of the Empire

Affiliation: General

Source: Official-Stock Ships (pg. 49-51), Pirates & Privateers (pg. 66)

Scale: Starfighter

Length: 54.8 meters

Skill: Space transports: HT-2200

Crew: 2

Passengers: 8

Cargo Capacity: 800 metric tons, in four cargo bays

Consumables: 3 months

Cost: 240,000 (new), 110,000 (used)

Hyperdrive Multiplier: x2

Hyperdrive Backup: x12

Nav Computer: Yes

Space: 3

Atmosphere: 260; 750 kmh

Hull: 5D

Shields: 1D

Sensors:

Passive: 10/0D

Scan: 25/1D

Search: 40/2D

Focus: 2/3D

Weapons:

2 Pulse Laser Cannons

Fire Arc: Turret

Scale: Starfighter

Skill: Starship gunnery

Fire Control: 2D

Space Range: 1-3/12/25

Atmosphere Range: 100-300/1.2/2.5 km

Damage: 4D

Notes: This vessel is easily modified; engineers gain a +5 bonus to their space transports repair rolls when per-

forming modifications on an HT-2200.

Capsule: HT-2200s had a significantly larger cargo capacity than any YT series vessel. They also had a stronger hull and greater baseline armament than the smaller YT series ships, though they were still lightly armed for their size. The design of the hull and power distribution systems allowed the installation of additional weapons, though this would necessitate the upgrading of the power generator as well. Most HT-2200 owners added new drive systems, the most popular being the 1L10 drive by Incom or drives from SoroSuub. Their main advantage over the YT series was in the design of the cargo bay. The cargo area of the HT-2200 was divided into four independent sections, each of which had its own environmental controls.

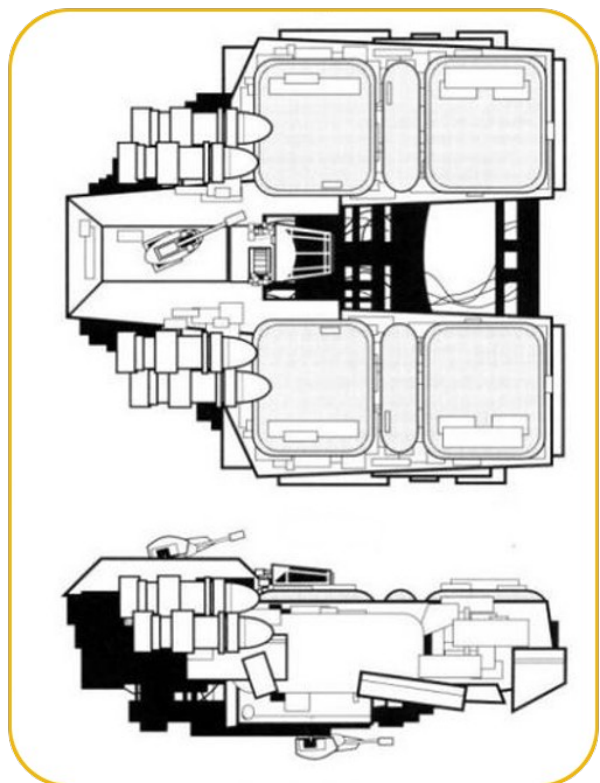

Addendum Personal- General Han Solo

If you want something to just haul cargo, than the '2200 is perfectly suited for that, but life as a blockade runner or smuggler would be better suited finding a faster ship...

RK-20 RESCUE SHIP

Craft: Corellian Engineering Corporation RK-20
Rescue Ship

Type: Rescue ship

Era: Rise of the Empire, Rebellion

Affiliation: General

Source: Arbitrary / Random-Homemade and appears to originate from RPGGAMER.org

Scale: Starfighter

Length: 82.5 Meters

Skill: Space Transports: RK-20

Crew: 32; Skeleton 11/+10

Crew Skill: Varies

Consumables: 2 Months

Passengers: 850

Cargo Capacity: 500 tons

Hyperdrive Multiplier: x1

Hyperdrive Backup: x12

Nav Computer: Yes

Space: 5

Atmosphere: 250; 850 kmh

Maneuverability: 1D

Hull: 3D

Shields: 1D

Sensors:

Passive: 50/0D

Scan: 80/1D

Search: 120/3D

Focus: 3/5D

Weapons:

4 Tractor Beam Projectors

Fire Arc: 1 front, 1 left, 1 right, 1 rear

Crew: 2 each

Scale: Starfighter

Skill: Capital Ship Gunnery

Fire Control: 2D

Space Range: 1-5/15/30

Atmosphere Range: 2-10/30/60 km

Damage: 5D

Capsule: Both the Clone Wars and the following Galactic Civil war led to massive casualties both among the various factions involved in them and in the civilian population caught up in the middle of the battles. While many ships were destroyed outright, many more were crippled leaving their crews fleeing in short range life-pods or left aboard a dying vessel with only limited life support left. The Corellian RK-20 Rescue Ship was designed to operate within fleets and from planetary surfaces to retrieve ship crew from crippled vessels. Equipped with tractor beams to bring aboard escape pods, large medical facilities and with plenty of space for the rescued people, as well as fairly fast drives to bring it to the site of any space disasters. These vessels have not proven popular with fleets, although many planets use them for rescues within their systems and countless people owe their lives to these dependable and versatile starships.



Addendum Personal- General Han Solo

You used to see more RK-20's then you do now, with the line being discontinued due to Imperial interference. They're primarily used for search and rescue.

CORELLIAN STARSPEED 280 PERSONAL YACHT

Type: Corellian Engineering Corporation 280 Personal Space Yacht

Era: Rise of the Empire, Rebellion

Affiliation: General

Source: Arbitrary / Random-Homemade and appears to originate from RPGGAMER.org

Scale: Starfighter

Length: 35 meters

Skill: Space transports: Starspeed 280 Yacht

Crew: 5, gunners: 1

Crew Skill: Varies widely

Passengers: 10

Cargo Capacity: 10 metric tons

Consumables: 3 months

Cost: 2,500,000 (New)

Hyperdrive Multiplier: x1

Hyperdrive Backup: x10

Nav Computer: Yes

Maneuverability: 2D

Space: 7

Atmosphere: 280; 800 kmh

Hull: 4D

Shields: 1D

Sensors:

Passive: 10/0D

Scan: 25/1D

Search: 40/2D

Focus: 2/3D

Weapons:

2 Laser Cannons (fire-linked)

Fire Arc: Turret

Crew: 1 (turret or cockpit)

Scale: Starfighter

Skill: Starship gunnery

Fire Control: 2D

Space Range: 1-3/12/25

Atmosphere Range: 100-300/1.2/2.5 km

Damage: 4D

Capsule: The Corellian Starspeed 280 Personal Yacht, simply called the Starspeed Yacht or the Starspeed 280, is C.E.C.'s attempt to create a reliable ship for the rich. It is a beautiful vessel and vaguely resembles a Mon Calamari ship. At the top towards the front of the vessel is a large observation deck where its passengers can view the stars. It also features large 'suites' for its passengers to live/sleep in which have their own bathroom and mini-kitchen.

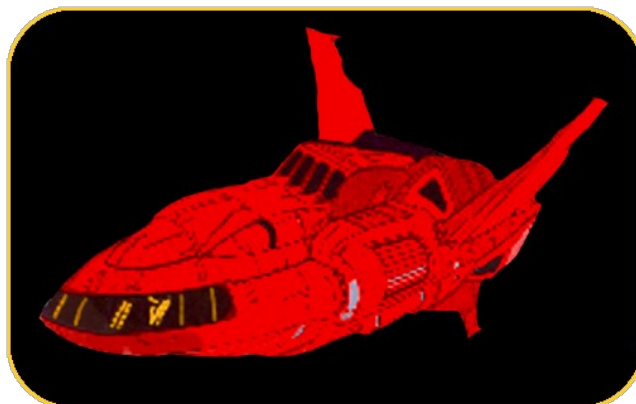

Addendum Personal- General Han Solo

If you can afford the price tag on the '280, then you don't have to worry about things like running cargo and 'carrying questionable contraband items through a customs blockade'. For what you're getting at that price, just save your money and modify the hell out of the ship you buy used, then you could retire travel the universe in style...

CHAPTER 3

CRF TRANSPORTS

I've been from one side of the universe to another and seen a lot of strange things, but the fact the Corellian Engineering Corporation has started copying their own product and attempted to remarket the ship as something completely different baffles even me, and I ain't someone that baffles easy...Take my word for it, the only thing a CRF transport is, is a HWK-290 freighter with a new paint job and plush Dewback leather seats.

Oh I know what you're sayin', how can I be so sure?

Well I know for a fact that they're the same ship because I happen to have been aboard *the Moldy Crow* on more than one occasion and at the last C.E.C. trade show on Corellia I took a long hard look at the CRF, you see at the time I was in the market for a new ship and wanted to get a closer look at what the Corellian Engineering Corporation was laying down and thought maybe I could pick one up. So there Chihdo and I were, y'know taking in the trade show, and I got to do a walkthrough of the CRF and imagine my surprise when I realize that it's nothing more than a HWK-290 knock off.

I was sorely disappointed, although I do have some fond memories of *the Moldy Crow* and Jan Ors...well y'know I ain't the type to kiss and talk, but me being the ladies' man that I am y'see, well lemme just say I got to see a lot more of *the Moldy Crow* then you're average person might have with me and Jan being so close and all. Kyle Katarn wasn't too happy about it, he threw a beating on me that I'm still recovering from and it's been years and years ago...It sort of reminded me of the time that Salla Zend tried to set my crotch on fire with that flaming green vanarx that she was drinking on Nar Shaddaa, that took a while to heal too. There was a bunch of pamphlets about the CRF layin' around and I can remember one of the quotes from them, mainly because it was the only thing not soaked through when I used it as napkin to clean up that Corellian Ale they were servin'

“The CRF maximizes speed and efficiency of movement while providing maximum comfort and affordability. Utilizing the newest ray shielding technology this light courier vessel not only offers the best protection money can buy, it gets you there in style as the plush Dewback leather seats will make

you the envy of all your friends and with the newly redesigned doublewide refresher space, even a wookiee with an upset tummy from eating to many Wookiee-ookiees will find enough room to relax and settle in with a good holo-novel!!!”

—Corellian Engineering Corporation specialist, Sven Vandangante.

Yeah, they used the refresher selling point to market these ships and I for one ain't impressed, because their ain't no amount of space large enough for a Wookiee with an upset stomach, take my word on it. I guess that's all from me about the CRF...Hey you C.E.C. guys said that Kyle Katarn is never gonna read this, right?

**Rik Duel,
'Free trader' and proud owner of 'The Moonshadow'**

CRF-78

LIGHT COURIER

Craft: Corellian Engineering Corporation CRF-78
Light Courier

Type: Light courier

Era: Rebellion

Affiliation: General

Source: Arbitrary / Random-Homemade and appears to originate from RPGGAMER.org

Scale: Starfighter

Length: 25m

Skill: Space Transports - CRF-78

Crew: 1

Crew Skill: varies

Passengers: 8

Consumables: 2 Months

Cost: 73,000 (new), 20,000 (used)

Cargo Capacity: 50 tons

Hyperdrive Multiplier: x1

Hyperdrive Backup: x12

Nav Computer: Yes

Space: 6

Atmosphere: 600; 1,200 kmh

Maneuverability: 2D+2

Hull: 4D

Shields: 2D

Sensors:

Passive: 20/0D+2

Scan: 40/1D+1

Search: 60/2D+2

Focus: 2/3D+2

Weapons:

Laser Cannon

Fire Arc: Turret

Scale: Starfighter

Skill: Starship Gunnery

Fire Control: 2D

Space Range: 1-3/12/25

Atmosphere Range: 100-300/1.2/2.5 km

Damage: 5D

Capsule: This fast and sleek courier ship has found a market with mercenaries and smugglers, both of whom love the maneuverability and speed of the vessel. Within its streamlined hull it has a fair sized cargo hold and generous passenger capacity, allowing a large amount of modification to improve the vessel far beyond its design specifications. When originally conceived, the CRF-78 was hoped to grab hold of some of the courier and messenger markets created as the Empire locked down control of the Holonet forcing information to be transported by starship.



Addendum Personal- General Han Solo

I can't help noticing how much this looks like HWK-290...

CRF-156T

FAST COURIER

Craft: Corellian Engineering Corporation CRF-156T Fast Courier

Type: Fast courier

Era: Rebellion

Affiliation: General

Source: Arbitrary / Random-Homemade and appears to originate from RPGGAMER.org

Scale: Starfighter

Length: 26m

Skill: Space Transports - CRF-156T

Crew: 1

Crew Skill: varies

Passengers: 2

Consumables: 3 Months

Cost: 180,000 (new), 56,000 (used)

Cargo Capacity: 20 tons

Hyperdrive Multiplier: x0.5

Hyperdrive Backup: x6

Nav Computer: Yes

Space: 8

Atmosphere: 650; 1,300 kmh

Maneuverability: 3D

Hull: 4D

Shields: 3D

Sensors:

Passive: 20/1D

Scan: 40/2D

Search: 60/3D

Focus: 2/4D

Weapons:

4 Laser Cannons (fire-linked)

Fire Arc: Front

Scale: Starfighter

Skill: Starship Gunnery

Fire Control: 2D

Space Range: 1-3/12/25

Atmosphere Range: 100-300/1.2/2.5 km

Damage: 7D

Capsule: The CRF-156T is a descendant of the CRF-78, and although not offering as great a cargo capacity, this vessel is a far superior combat vessel. Despite being released before hand the CRF-156T became available after the Battle of Endor, having been banned by Imperial restrictions, on what they called 'combat vessels'. Sales of the CRF-156T are monitored by the New Republic, as this vessel seems certain to attract the attention of those whose activities are somewhat nefarious and illegal. A number of CRF-156T have actually been put to their named purpose, and act as message carriers and courier vessels to a number of reputable companies which stops this vessel from becoming a recognizably criminal vessel.



Addendum Personal- General Han Solo

Now that I am seeing these ships, they both look like HWK-290...

CHAPTER 4

VCX FREIGHTERS

First let me say that it is an honor to have been picked as one of the many people getting to talk about the hard work and dedication that the Corellian Engineering Corporation has displayed over the years, as a free trader and freighter captain myself I have been a proud owner of a YT-1300 for some time now and after opening my own shipping company after the end of the war, I made sure to 'buy Corellian' when it came to outfitting my pilots with the best equipment that credits could buy. Not enough can be said about the equipment used to keep a ship in the air and often times the laymen has no idea just how much hard work and dedication it takes to keep a ship going. Finding a good crew is hard work and making sure that you keep the ship up and running is even harder...

It isn't just something as simple as buying a 'better' cannon or shield generator, those are things that anyone can get in any supply house. Sometimes it's just in the way that a crew works together in those split second life changing decisions that make all the difference. A lot can be said about what type of cannon to buy or the kind of maneuverability thruster to install; but at the end of the day if your crew doesn't know what it's doing then all the expensive equipment in the universe can and won't be able to help them when it comes down to the crucial moment when you need it.

The VCX freighter class was introduced around the time of the Clone Wars and in a way was made famous by members of a group of fledgling Rebels fighting for the rights of the little people in the Lothal system. These ships were designed fast and strong from the ground up and if you have ever seen one of them in action, it has a get up and hustle that makes me envious that I didn't borrow credits from Bib Fortuna to buy a VCX-100 like my good friend Hera Syndulla, although to be honest I never did hear how she scratched up the credits to get *'The Ghost'*, but she was a helluva teacher when it came to learning the finer details on running cargo and flying by the seat of my pants. Even though I haven't seen her in years, Hera was a woman of action and when she spoke her mind she meant what she said. I couldn't find any quotes about her ship *'The Ghost'*, but she did have this to say about what a good crew means to the captain of freighter...

"My crew is my family away from my family and our ship is the only home that we can all come back to at the end of the day. It takes all of us to keep 'The Ghost' up in the air and running, sometimes the jobs are just about putting food on the table and in our bellies and other times it's all about getting some fuel just to get to the next place. We fight like a family amongst ourselves, but you had better believe that no one gets to fight one of us without drawing the ire of the entire crew. In the end, if all you do is fight for your own life, then your life is worth nothing because we're all in it for the long haul."

-Hera Syndulla

I had the pleasure of working of working with the Republic in the aftermath of the war, I was angry and upset after my parents were murdered by the Empire while on a diplomatic mission to Alderan. They never got to see the friends I made or the man I grew up to be. My crew on *'The Centennial Hawk'* became my family and the ship *our* home, they went on countless adventures with me, we saw the galaxy from one side to another and back again and in the end we all became a part of the universe that we spent so much time running from. Through them I met my wife and eventually my kids started playing with their kids and it all had to do with a crew on a freighter and the adventures we undertook for General Wayne...

**Kazdan Navarro,
Owner of *the Centennial Hawk* and Navarro Shipping.**

VCX-100

LIGHT FREIGHTER

Craft: Corellian Engineering Corporation VCX-100 Light Freighter

Type: Light freighter

Era: Dark Times, Force Unleashed

Affiliation: General

Source: Fan-made-Modeled by Panzerjedi from 'The Phantom' in Star Wars: Rebels.

Scale: Starfighter

Length: 44 meters

Skill: Space transports: VCX-100

Crew: 1 to 3

Crew Skill: Varies

Passengers: 6

Cargo Capacity: 150 metric tons

Consumables: 6 months

Cost: 150,000 (New), 30,000 (Used)

Hyperdrive Multiplier: x2

Hyperdrive Backup: x12

Nav Computer: Yes

Maneuverability: 1D+1

Space: 5

Atmosphere: 295; 850 kmh

Hull: 5D

Shields: 1D+1

Sensors:

Passive: 10/0D

Scan: 25/1D

Search: 40/2D

Focus: 2/3D

Weapons:

2 Twin Laser Cannons

Fire Arc: 1 Turret, 1 Partial Turret (Front, Right, Left)

Crew: 1 or Pilot

Scale: Starfighter

Skill: Starship gunnery

Fire Control: 2D, (0D when Locked Forward and Controlled by the Pilot)

Space Range: 1-3/12/25

Atmosphere Range: 100-300/1.2/2.5 km

Damage: 4D

VCX-101-BUD

SHORT-RANGE SHUTTLE

Craft: VCX-101-BUD-Companion Corellian Short-Range Shuttle Fighter

Type: Short-range shuttle

Era: Dark Times/Force Unleashed

Affiliation: General

Source:

Skill: Space Transports: VCX-101-Companion

Length: 12 meters

Crew: 1

Passengers: 4

Consumables: 2 weeks

Cost: 30,000 (New), 10,000 (Used) (These shuttles come as an upgrade to VCX-101)

Hyperdrive Multiplier: None

Hyperdrive Backup: None

Nav. Computer: No

Cargo Capacity: 600 kilograms

Maneuverability: 2D

Space: 6

Atmosphere: 330; 950 kmh

Hull: 4D

Shields: 1D

Sensors:

Passive: 10/0D

Scan: 25/1D

Search: 40/2D

Focus: 2/3D

Weapons

Dual Medium Laser Cannons (fire-linked)

Fire Arc: Front

VCX TRANSPORTS

Crew: 1

Scale: Starfighter

Skill: Starship gunnery

Fire Control: 2D

Space Range: 1-5/10/17

Damage: 5D

Top Turret Light Laser Cannon

Fire Arc: Turret

Crew: 1

Scale: Starfighter

Skill: Starship gunnery

Fire Control: 2D (0D when Locked Forward and Controlled by the Pilot)

Space: 1-5/10/17

Damage: 3D

Game Notes: Since this Vessel and its Companion Shuttle are so easily modified, engineers add a +5 BONUS to their Space Transports Repair Skill rolls when performing modifications.

Capsule: Released just after the clone wars, the VCX-100 and Its Companion shuttle, was the First of the VCX freighter Line. A return to the extremely easy to modify philosophy of the YT-Series, it was well received and though this light freighter and its companion short range shuttle were very popular and rugged, intended for long runs in the outer-rim and wild space. Though the small short range lander was popular enough on its own to merit separate sales, the combo mother ship/shuttle setup, was dropped for later VCX Models. The VCX-100's design was versatile enough it could serve as a Trading Vessel, Scout Vessel, or even be converted to a military craft or any number of roles...The model was popular and stayed in production, well after the fall of the Galactic Empire, even as new VCX-Series models were released.



Addendum Personal- General Han Solo

I've never been on a '100 before, but my buddy Lando has and from what he said this thing is pretty comfy, with multiple decks and a small shuttle craft for planet hopping if need be. Looking over the technical specs, I'd say that this little lady is worth the credits you'd spend to get her...



VCX-350

FREIGHTER

Craft: Corellian Engineering Corporation VCX-350 Light Freighter

Type: Light freighter

Era: New Republic

Affiliation: General

Source: Converted- Star Wars Gamer 2.

Scale: Starfighter

Length: 31 meters

Skill: Space transports: VCX-350

Crew: 2, gunners: 1

Crew Skill: Varies

Passengers: 8

Cargo Capacity: 250 metric tons

Consumables: 6 months

Cost: 300,000 (new), 175,000 (used)

Hyperdrive Multiplier: x1

Hyperdrive Backup: x11

Nav Computer: Yes

Maneuverability: 1D+1

Space: 8

Atmosphere: 365; 1,050 kmh

Hull: 5D

Shields: 2D

Sensors:

Passive: 10/0D

Scan: 25/1D

Search: 40/2D

Focus: 2/3D

Weapons:

2 Laser Cannons (fire-linked)

Fire Arc: Front

Crew: 1

Scale: Starfighter

Skill: Starship gunnery

Fire Control: 2D

Space Range: 1-3/12/25

Atmosphere Range: 100-300/1.2/2.5 km

Damage: 5D+1

Capsule: The VCX-350 light freighter was a Corellian Engineering Corporation starship in the VCX series introduced to the starship market during the transition of power from the Galactic Empire to the New Republic. Benefiting from the New Republic's less-intrusive policies toward independent companies, C.E.C. was able to create a more powerful freighter; the end result combined lavish staterooms, a large cargo hold, and heightened performance.

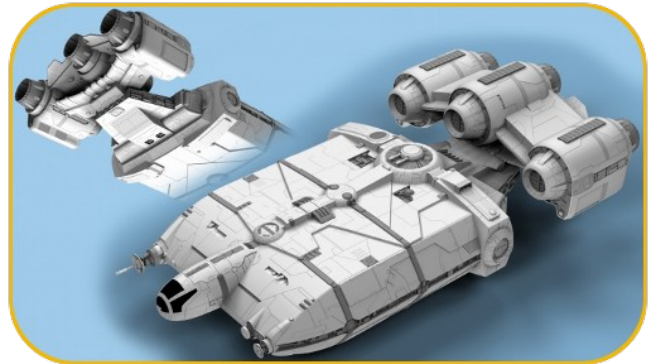

Addendum Personal- General Han Solo

I'm seeing more and more of these high priced cargo ships and wondering just who would be buying them? Freighter captains, between tariffs, fees and taxes barely break even so the idea that someone would spend over a quarter million credits on one of these things just seems a tad ridiculous.

VCX-700

HEAVY COURIER

Craft: Corellian Engineering Corporation VCX-700 Heavy Courier

Type: Light Freighter

Era: New Republic

Affiliation: General

Source: Converted- Star Wars Gamer 2

Scale: Starfighter

Length: 26 meters

Skill: Space Transports: VCX-700

Crew: 1+4 gunners

Crew Skill: Varies

Passengers: 6

Cargo Capacity: 5 metric tons

Consumables: 1 month

Cost: 350,000 (new), 250,000 (used)

Hyperdrive Multiplier: x1

Hyperdrive Back-Up: x12

Nav Computer: Yes

Maneuverability: None

Space: 7

Atmosphere: 350; 1000 kmh

Hull: 5D

Shields: 3D

Sensors:

Passive: 10/0D

Scan: 25/1D

Search: 40/2D

Focus: 2/3D

Weapons:

2 Heavy Laser Cannons (fire-linked)

Fire Arc: Turret

Crew: 1

Scale: Starfighter

Skill: Starship Gunnery

Fire Control: 2D

Space Range: 1-3/12/25

Atmosphere Range: 100-300/1.2/2.5 km

Damage: 5D+1

4 Light Ion Cannons (fire-linked)

Fire Arc: Front

Crew: 1

Scale: Starfighter

Skill: Starship Gunnery

Fire Control: 1D

Space Range: 1-3/7/36

Atmosphere Range: 100-300/700/3.6 km

Damage: 5D

Autoblaster

Fire Arc: Front

Crew: 1

Scale: Starfighter

Skill: Starship Gunnery

Fire Control: 4D

Space Range: 1-3/10/20

Atmosphere Range: 100-300/1/2 km

Damage: 3D+1

2 Dual Concussion Missile Launchers (fire-linked)

Fire Arc: Front

Crew: 1

Scale: Starfighter

Skill: Projectile Weapons: Concussion Missiles

Fire Control: 1D

Space Range: 1/3/7

Atmosphere Range: 50-100/300/700

Ammo: 12 salvos (6 each)

Damage: 9D+1

Capsule: The VCX-700 heavy courier was a 26-meter-long armed courier produced by Corellian Engineering Corporation. Like the rest of the VCX series, the VCX-700 was equipped as standard with near-military grade engines, shields, and weapons. Unlike the earlier VCX-350 light freighter, the VCX-700 sacrificed cargo capacity for armament, and was equipped with a dual laser cannon turret, four ion cannons, an auto-blaster, and four concussion missile launchers. It could only

VCX TRANSPORTS

carry 5 tons of cargo, but its strong armament and heavy armor plating made it well-suited to protecting VIP passengers. The VCX-700's hull configuration superficially resembled the Trade Federation's Armored Assault Tank, with engines mounted above and behind a hemispherical main hull, while other aspects of the design resemble the Firespray-class in its landed configuration, such as the loading ramp beneath the tail section, the tail mounted cannon and the top silhouette.

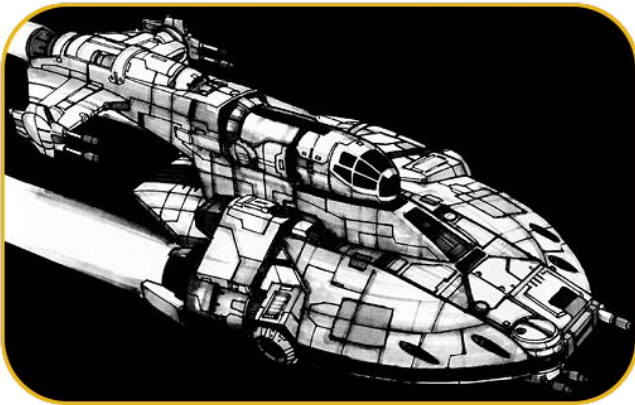

Addendum Personal- General Han Solo

This thing looks a little too much like 'Slave-1' for my tastes...

VCX-760

SCOUT GUNBOAT

Craft: Corellian Engineering Corporation VCX-760

Type: Scout Gunboat

Era: Rise of the Empire

Affiliation: General

Source: Arbitrary / Random-Star Wars: Rebellion video game, stats by crmcneill

Scale: Starfighter

Length: 20 meters

Skill: Space Transports: VCX-760

Crew: 3 (can coordinate) + 2 gunners

Crew Skill: Skills vary

Passengers: None

Cargo Capacity: 10 metric tons

Consumables: 2 months

Hyperdrive Multiplier: x1

Hyperdrive Backup: x12

Nav Computer: Yes

Maneuverability: 1D

Space: 6

Atmosphere: 330; 950 kmh

Hull: 5D

Shields: 2D

Sensors:

Passive 35/1D

Scan 50/2D

Search 75/3D

Focus 5/3D

Weapons:

2 Turbo-Laser Cannon

Fire Arc: 1 Front/Left, 1 Front/Right (can be fire-linked in the Front arc)

Crew: 1 (pilot or co-pilot)

Scale: Starfighter

Skill: Starship Gunnery

Fire Control: 1D

Space Range: 3-15/35/75

Atmosphere Range: 300-1.5/3.5/7.5 km

Damage: 7D

2 Dual Laser Cannon

Fire Arc: Turret (Ventral & Dorsal)

Crew: 1 each

Scale: Starfighter

Skill: Starship Gunnery

Fire Control: 3D

Space Range: 1-3/12/25

Atmosphere Range: 100-300/1.2/2.5 km

Damage: 5D

2 Quad-Blaster Cannon (fire-linked)

Fire Arc: Front

Crew: 1 (pilot or co-pilot)

Scale: Starfighter

Skill: Starship Gunnery

Fire Control: 3D

Space Range: 1-5/10/17

Atmosphere Range: 100-500/1/1.7 km

Auto-Fire: 2D*

Damage: 4D

* Can be applied to Damage or Fire-Control at Gunner's discretion, must be declared prior to the shot. Can only be applied to Fire Control at Long Range, and only 1D may be applied to Damage at Medium Range.

2 Proton Torpedo Launchers (fire-linked)

Fire Arc: Front

Crew: 1 (pilot or co-pilot)

Scale: Starfighter

Skill: Starship Gunnery

Fire Control: 1D

Space Range: 1/3/7

Atmosphere Range: 50-100/300/700

Ammo: 16 torpedoes (magazine feeds both launchers)

Damage: 9D

Capsule: The C.E.C. VCX-760 is a potent multi-role combat starship. While not found in Imperial service, it

VCX TRANSPORTS

is popular among system defense forces, as well as some Rebel units. Its weapon suite is well-balanced, allowing the ship to engage targets ranging from air-speeders up to small capital ships. In addition, its sensor suite allows it to serve as an armed scout and fleet picket. While it has not entered Alliance service in great numbers, its popularity is rapidly growing.



Addendum Personal- General Han Solo

I've never seen the '760 before today and while I can't say that I have ever seen one in action, I can say that it looks like something out a Tri-D action serial or some kinda game. There is no way that the C.E.C. could have legally built this while the war was going on, my belief is that it's a fantasy concocted by some starship designer looking to see how many weapons they could cram into one ship...

VCX-820 ESCORT FREIGHTER

Craft: Corellian Engineering Corporation VCX-820
Escort Freighter

Type: Escort freighter

Era: New Republic

Affiliation: General

Source: Converted- Star Wars Gamer 2

Type: Light Freighter

Scale: Starfighter

Length: 20.2 meters

Skill: Space Transports: VCX-820

Crew: 2+6 gunners

Crew Skill: Varies

Passengers: None

Cargo Capacity: 1 metric ton

Consumables: 6 months

Cost: 450,000 (new), 300,000 (used)

Hyperdrive Multiplier: x2

Hyperdrive Back-Up: x12

Nav Computer: Yes

Maneuverability: 1D

Space: 6

Atmosphere: 330; 950 kmh

Hull: 5D

Shields: 6D

Sensors:

Passive: 20/1D

Scan: 35/1D+1

Search: 80/2D+1

Focus: 2/3D

Weapons:

2 Twin Heavy Laser Cannons

Fire Arc: Turret

Scale: Starfighter

Skill: Starship Gunnery

Fire Control: 2D

Space Range: 1-3/12/25

Atmosphere Range: 100-300/1.2/2.5 km

Damage: 5D+1

4 Double Autoblasters

Fire Arc: Partial Turrets (front, left, right)

Scale: Starfighter

Skill: Starship Gunnery

Fire Control: 4D

Space Range: 1-3/10/20

Atmosphere Range: 100-300/1/2 km

Damage: 3D+2

Proton Torpedo Launcher

Fire Arc: Front

Scale: Starfighter

Skill: Projectile Weapons: Proton Torpedoes

Fire Control: 3D

Space Range: 1/3/7

Atmosphere Range: 50-100/300/700

Ammo: 16 torpedoes

Damage: 9D

Capsule: The VCX-820 escort freighter was a freighter designed several years before the Yuuzhan Vong War. It was a heavy, fast, "flying guns"-platform. With its 8 autoblasters, it could easily guard convoys of otherwise defenseless bulk freighters and commerce craft. Designed with military requirements, it was nonetheless reasonably priced on the civil market. Originally, the VCX-820 was designed for the Imperial Remnant, but invasion by the Yuuzhan Vong caused many smugglers and private traders to seek out a vessel that would allow for protected travel through profitable, yet highly dangerous, space lanes. As a result of this desire, many larger trade-firms invested in these vessels, making it quite common during the hard times of the New Republic.

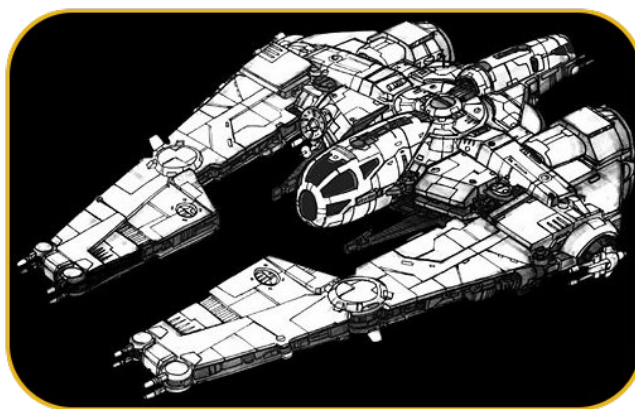

Addendum Personal- General Han Solo

I wish I could get a shield rating like that on the Falcon...

CHAPTER 5

XS FREIGHTERS

I was seventeen standard years old when I borrowed the credits from Talon Karrde to purchase my Yt-1300 freighter ‘*The Century Hawk*’; I was full of spit and vinegar and wanted to show the rest of the galaxy, what I assumed I already knew. That I was the best freighter pilot, this side of my father, and that in doing so I could finally prove myself as his daughter and be accepted into his family. I grew up on Corellia, my mother worked in the bars near the docks and I would watch and hope that one day dad would come sweeping in and that he would take me away from ‘Low-town’ and that I would go off with him on his ship, the two of us going on adventures and staying one step ahead of the Imperials, Corsec of the local Sector Rangers. Being an out of wedlock child in a lower income section of Corellia, which runs rampant with that sort of thing was hard enough; and any child who goes through that, at some point in their life, will yearn for the day when the parent(s) they dream of will come through the doors and rescue them from the life they’ve been living.

I was no different. My mother wasn’t the greatest role model in the known galaxy and as mother’s go she was actually pretty lousy, rampant alcoholism and spice addiction will do that to you I guess...I had just turned eleven and was running the streets of ‘Lowtown’ with a gang of kids, we were down by the Corellian Engineering Corporation repair docks and I got turned around enough to get lost and when I rounded a corner I found myself looking through the bay doors of the repair docks at an Corellian XS Light Freighter. I have no idea where they had found it, maybe the back of some junk yard or drifting dead in space, but to my very young eyes it was the most beautiful thing I had ever seen. In that instant it represented freedom from a life that I desperately wanted to escape from and yet, until that moment I had never dreamt such a thing was possible. I learned everything I could about the XS freighter class dreaming that one day *I* would own one and prove myself worthy of being called a freighter pilot.

Designed by Bravis Halcyon the XS freighter was eighty-eight meters in length and one hundred and one meters wide, huge when you compare it to a standard Yt-1300 although I have heard those figures disputed I can tell you that the one I saw all those years ago was gigantic, but then again I was eleven standard years old. I started studying that day and pes-

tering all the local pilots my mother was friendly with and it didn’t take long before I was helping load cargo or working on ships and with some hard work and studying I became a decent enough pilot that when mother died I was able to strike out on my own. In the end it was the outlawed words of Bravis Halcyon that spurred me into action.

“Be daring, be different, be impractical, be anything that will assert integrity of purpose and imaginative vision against the play-it-safers, the creatures of the commonplace, the slaves of the ordinary, and in the end if you are brave in all your endeavors then the Force will come to your aid, always.”

-Bravis Halcyon

A few years after I left Corellia I met the man I thought was my father and I got up enough nerve to talk to him, thanks in part to a very friendly Wookiee. A simple conversation and ten minutes in a med-center proved that we were relatives, but not father and daughter. As it turned out that honor fell to his older cousin, who is noted for his startling resemblance to the one time smuggler turned war hero general...

**Danielle Kieran,
‘Free trader’ and proud owner of *The Century Hawk*.**

CORELLIAN

XS

LIGHT FREIGHTER

Type: Light Freighter
Era: Old Republic
Affiliation: General
Source: Fanmade/Inferred-Stats based on Star Wars the Old Republic MMO.
Scale: Starfighter
Length: 27 Meters
Skill: Space Transports: XS Light Freighter
Crew: 2; skeleton 1/+10
Passengers: 6
Consumables: 3 Months
Cargo Capacity: 80 tons
Hyperdrive Multiplier: x2.5
Hyperdrive Backup: x25
Nav Computer: Yes
Space: 5
Atmosphere: 250; 850 kmh
Maneuverability: 2D
Hull: 4D
Shields: 1D
Sensors:
Passive: 10/1D
Scan: 25/1D+2
Search: 40/2D
Focus: 2/3D

Weapons:

2 Twin Laser Cannon Turrets
Fire Arc: Turret
Crew: 1
Scale: Starfighter
Skill: Starship gunner
Fire Control: 2D
Space: 1-5/8/20
Atmosphere Range: 100-500/800/2 km
Damage: 4D

Torpedo Battery
Fire Arc: Front

Crew: 1
Scale: Starfighter
Skill: Starship gunnery
Fire Rate: 1/2
Fire Control: 1D
Space: 1-2/4/7
Atmosphere Range: 25-200/400/700
Damage: 7D

Capsule: The classic Freighter has advanced by leaps and bounds since the Dynamic class Freighters from the days of the Jedi Civil War. The freighter is larger and more versatile than its predecessors, and the XS Freighter model also features a variety of significant upgrades that make it one of the fastest and most nimble ships in the galaxy. In addition to an enlarged cargo hold, the XS also has secret compartments throughout the ship for transporting contraband and anything else the captain would prefer to keep hidden. If the captain prefers to simply avoid being boarded, the XS has proven itself to be fully capable. In addition to the standard laser and torpedo batteries, the starship is designed with upper and lower turrets that can be controlled manually or remotely from the cockpit. Captains of these freighters typically live on board, so the XS Freighter has all the creature comforts anyone could ask for, from a recreational lounge to extra sleeping quarters. It's no wonder that it inspires such loyalty in its owners.



Addendum Personal- General Han Solo

I've seen Tri-D holo-pic of these and I've even seen a couple of them restored to functional use, you can see where the '1300 got its start from and if the Falcon hadn't come my way, it might have been a restored XS freighter for me...

XS-800

LIGHT FREIGHTER

Craft: Corellian Engineering Corp. XS-800 Light Freighter

Type: Light freighter

Era: Rebellion

Affiliation: General

Source: Stock Ships (pages 21-23)

Scale: Starfighter

Length: 30.2 meters

Skill: Space transports: XS-800

Crew: 1 to 2 (can coordinate)

Passengers: 8

Cargo Capacity: 115 metric tons

Consumables: 2 months

Cost: 37,500 (new)

Hyperdrive Multiplier: x3

Hyperdrive Backup: x15

Nav Computer: Yes

Maneuverability: 2D

Space: 6

Atmosphere: 330; 950 kmh

Hull: 3D

Shields: 1D+2

Sensors:

Passive: 15/0D

Scan: 30/1D

Search: 50/3D

Focus: 2/4D

Weapons:

Double Laser Cannon (fire-linked)

Fire Arc: Front

Crew: 1

Scale: Starfighter

Skill: Starship gunnery

Fire Control: 2D

Space Range: 1-3/12/25

Atmosphere Range: 100-300/1.2/2.5 km

Damage: 4D

Capsule: The biggest advantage of this ship was the passengers' comfort. Personal refresher stations, independent climate control for each quarters, and fold-out bunks made it a very comfortable ship for long journeys. Two escape pods capable of each seating five people are equipped on the XS-800. Also, the cockpit was designed to separate from the ship and land on a planet when there was no other way to rescue passengers and crew. Safety was also guaranteed by its double laser cannon. It was a very successful craft, but not as popular as other Corellian Engineering Corporation ships, like the CR90 corvette.



Addendum Personal- General Han Solo

I like that one of the big selling points on the 'mini-vette', which is what Chewie and I took to calling these, is that it has personal refresher stations...

CHAPTER 6

YB AND YC FREIGHTERS

Back before the universe had ever heard of ‘Han Solo, war hero’ he was just ‘Han Solo, smuggler’ and to be more than a little frank about the matter, he ain’t no different than me. Oh sure he has a life-debted Wookiee companion to run around with and ‘the fastest hunk of junk in all the galaxy’ to fly in, but you know what I say?

Big damn deal.

I’ll give it to you straight and honest; Solo has got more luck than any man I have ever met in my life. Not only does he win the ship of his dreams in a card game, he won the money to fix her up and got a girl on his arm that most men would sell their ships to have. He gets the big time publishing contract to give his personal seal of approval to all of these ships and what do I get? A section with two ships that no one has ever heard of before, the least he could have done was invited me to make commentary on the YT-2400, do I even get that?

No.

So let me give you some insight into these two ships, that I know nothing about, have no personal interest in and have never seen before I sat down to write out this introduction, for which I am getting the princely (or is it, princessly, in the case of Solo being involved...) sum of five hundred credits. So I’m thinking that you should probably get your credits worth for my hard work slaving on this catalog at the keyboard in a two-fingered typing style last seen during my days in the Imperial academy long, long ago, back when the families name actually meant something.

I know nothing about either ship, other than to say that one looks like a slightly redesigned Corellian Corvette and how that one didn’t get included in the ‘Bulk freighters’ chapter I’ll never know and the other looks suspiciously like a droid transport vessel circa the blockade of Naboo. Although in the case of that one, it would be fairly obvious to me why no one threw much of a fuss about their design being stolen, since they were the loosing *droid* army...I was able to get up an archival quote about the ships that points to a decent litigator droid having a case against the Corellian Engineering Cor-

poration for infringing upon trademarked materials.

“Both the YB and YC freighters utilizing existing ship designs in an effort to create customer marketplace comfort for the savvy and wise purchaser willing to forgo the standard fare and look for something just a tad...different. Both come with standard three million light year warranty packages on all parts and repairs, assuming of course that the owner doesn’t violate the warranty by doing something that could be construed as illegal by local, sector or galactic law-enforcement.”

–Phre’tac Spren, public relations official for the Corellian Engineering Corporation.

So there you have my input on this master piece and I plan to collect my credits and go drink myself blind, I hope Solo chokes on his...

**Dash Rendar,
Proud owner of the Outrider and Outrunner.**

YB-300 HEAVY FREIGHTER

Craft: Corellian Engineering Corporation YB-300 Heavy Freighter

Type: Heavy freighter

Era: Rise of the Empire

Affiliation: General (private, corporations)

Source: Arbitrary / Random-Homemade and appears to originate from RPGGAMER.org

Scale: Starfighter

Length: 75 meters

Skill: Space transports: YB-300

Crew: 2 Skeleton: 1/+10

Crew Skill: Varies widely

Passengers: 4

Cargo Capacity: 1200 metric tons

Consumables: 6 months

Cost: 60,000 (used)

Hyperdrive Multiplier: x2

Hyperdrive Backup: None

Nav Computer: Yes

Maneuverability: 1D

Space: 5

Atmosphere: 260; 750 kmh

Hull: 4D+2

Shields: 2D

Sensors:

Passive: 25/1D

Scan: 50/2D

Search: 65/3D

Focus: 3/4D

Weapons:

None

Capsule: The YB-300 is a heavy freighter designed to fill the gap between the smaller YT series of freighter, and the larger bulk freighters transport ships. This design of vessel sold only moderately well, with it

being too large and expensive for owner captains to buy, but too small for the bulk transport companies to use. However it has made a successful life in the second hand market where it makes a large and comfortable living for the captain who buys a used YB-300 rather than a newer light freighter. With plenty of room for modifications, and a large hold to hide smuggling compartments within, many of these vessels now find themselves operating as the ships of smugglers and pirates.



Addendum Personal- General Han Solo

No back Hyperdrive or weapons puts the owner in the position of having to pay for upgrades on a ship that you're gonna have to scrounge parts for and that are no longer being made to begin with. Yeah, the cargo capacity is nice, but with all the credits you'd have to put into upgrades.

YC-1200

PERSONNEL TRANSPORT

Craft: Corellian Engineering Corporation YC-1200
Personnel Transport

Type: Personnel transport

Era: Rise of the Empire, Rebellion

Affiliation: General

Source: Arbitrary / Random-Homemade and appears to originate from RPPGAMER.org

Scale: Starfighter

Length: 18m

Skill: Space Transports - YC-1200

Crew: 1

Crew Skill: varies

Passengers: 11

Consumables: 1 Month

Cargo Capacity: 20 Tons

Cost: 22,000 (used)

Hyperdrive Multiplier: x2

Hyperdrive Backup: None

Nav Computer: Yes

Space: 5

Atmosphere: 520; 900 kmh

Maneuverability: 2D

Hull: 4D

Shields: 2D

Sensors:

Passive: 25/0D

Scan: 50/1D

Search: 75/2D

Focus: 2/2D+2

Weapons:

Light Laser Cannon

Fire Arc: Front

Crew: 1

Scale: Starfighter

Skill: Starship Gunnery

Fire Control: 2D

Space Range: 1-3/15/25

Atmosphere Range: 100-300/1.5/2.5 km

Damage: 3D

Capsule: The YC-1200 is a personnel shuttle, designed to transport a few passengers from place to place much in the same way as the Lambda class shuttle does for the Empire. The YC-1200 was produced during the final years of the Old Republic, and was bought in droves by the Old Republic itself for transporting tax inspectors and other officials between member worlds, chosen for this role because of its good speed and ability to defend itself. YC-1200's are now rarely seen due to their small cargo hold and poor weaponry compared to newer vessels, C.E.C. has ceased production although the vessel shares parts with the YT series of transports so the remaining examples of this vessel are generally well maintained and operational.



Addendum Personal- General Han Solo

"small cargo hold and poor weaponry compared to newer vessels" that says it all...

CHAPTER 7

YG TRANSPORTS

Not a lot gets said about space exploration and I think that a lot of that has to do with the fact that for the most part, we have explored the known galaxy and got to a point where we just don't want to go any further. I'm not sure if that is more out of fear of what might be out there or the current limitations of our technology. To be afraid of the unknown and unwilling to explore further is to give into some foreboding trepidation of what may lay beyond the known galaxy and on that path there can be no advancement of our explorative nature, no broadening of our horizons, only stunted un-growth...Ultimately a sense of the unknown has always moved societies to leave their own planets and to push themselves out into the great expanse in exploration of what is beyond their own horizons. The greatest unknown, as it stands now, is the '*Unknown Regions*' and yet all civilizations have that overwhelming need to go off and explore, to find out what is around the next corner and beyond their own borders, it's a part of our being and moral fiber that pushes us, but at the same time fear of what we might find gives us pause and second thoughts about which way to go next.

If I had given into fear all those years ago, I would never have left Corellia or the academy. I would never have walked the sandy dunes of Tatooine or wandered the back alleys of 'Smugglers Run'. Instead I would have forever stayed on Corellia with my head buried in a data-terminal avoiding life and running from the need to go off and explore. It saddens me that of all the exploration vehicles that the Corellian Engineering Corporation has created, these are the only two still being produced and that the Outbound Flight Project was abandoned because of one failure is to me a tremendous loss for the collective society who dreamt of all that could have been found and still yet waits for us to find whatever it might be in the unknown regions...

Simply put the YG-vessels were designed for deep space explorations, allowing us to travel to regions formerly unknown and to seek out life that is strange and exciting, to make new friends and meet civilizations that would greet us with open arms. With large caches of consumables and superior life support systems these ships were specifically designed to reach out into the heavens above and beyond our normal borders. They were designed by Ilheim Crickhollow, whose dream it was to explore the areas of space that the Re-

public had not yet touched on.

"Life is forever dying to be born anew and refreshed, forever young and eager in the chase to find new paths and horizons to explore, all beings will stand upon their own planets at some point as a youngling might upon a hillside, and stretch out their limbs to reach out and attempt to touch the stars above them. This is a collective dream that we all share, one that spurs us from thought to movement and action for inevitably we all are in the sluiceway of life gathered together, the difference is that some of us are looking to stars and waiting to be moved..."

-Ilheim Crickhollow

Simply, but moving words, said by a man whose dream is dying.

But it doesn't have to, take this moment now and put digits to datapads and communicate with the Corellian Engineering Corporation letting them know that you're for further exploration of the unknown regions. Don't let another moment pass without speaking your mind and telling them how you feel about the matter. We must continue to explore and to bravely go where we have never been before, seeking out new lifeforms no matter what they look like, to reach new civilizations and horizons or we are doomed to remain here, stunted and ungrowing, repeating the same history over and over again.

**BoShek,
Space explorer, free trader and proud owner of *The Infinity***

YG-750 TRANSPORT

Craft: Corellian Engineering Corporation YG-750
Space Transport

Type: Space transport

Era: Rise of the Empire, Rebellion

Affiliation: General

Source: Arbitrary / Random-Homemade and appears to originate from RPGGAMER.org

Scale: Starfighter

Length: 25m

Skill: Space Transports - YG-750

Crew: 1

Crew Skill: varies

Passengers: 2

Consumables: 4 Months

Cargo Capacity: 90 Tons

Cost: 23,000 (used)

Hyperdrive Multiplier: x2

Hyperdrive Backup: None

Nav Computer: Yes

Space: 4

Atmosphere: 480; 800 kmh

Maneuverability: 2D

Hull: 4D

Shields: 1D

Sensors:

Passive: 25/0D

Scan: 45/1D

Search: 65/2D

Focus: 2/3D

Weapons:

Twin Heavy Laser Cannons

Fire Arc: Turret

Crew: 1

Scale: Starfighter

Skill: Starship Gunnery

Fire Control: 2D

Space Range: 1-3/15/25

Atmosphere Range: 100-300/1.5/2.5 km

Damage: 6D

Capsule: The YG series of light freighters was designed to be smaller vessels than the YT series, and more modifiable into combat vessels, the YG-750 for instance come ready for outfitting for missile launchers and changes into a patrol and assault craft. This marketing however was even more squarely aimed at the pirate market than the YT series, and the YG range was retired from production after heavy pressure from the Empire. The YG-750 is however a perfectly serviceable cargo vessel, and although a little small, especially once better engines and shields have been fitted, the ship has a record of reliability that makes it a worthwhile investment for any starting out freighter captain.



Addendum Personal- General Han Solo

This looks like something out of one of my kid's Tri-D holo-games...

YG-4210

TRANSPORT

Craft: Corellian YG-4210 Transport

Type: Exploration freighter

Era: Old Republic

Affiliation: General

Source: Converted- Star Wars Gamer 2

Scale: Starfighter

Length: 24 meters

Skill: Space transports: YG-4210

Crew: 1, gunners: 2

Crew Skill: Varies widely

Passengers: 12

Cargo Capacity: 25 metric tons

Consumables: 1 year

Cost: 40,000 (used)

Hyperdrive Multiplier: x3

Hyperdrive Backup: None

Nav Computer: Yes

Maneuverability: 1D

Space: 3

Atmosphere: 260; 750 kmh

Hull: 4D

Sensors:

Passive: 10/+1

Scan: 25/1D

Search: 40/2D

Focus: 2/3D

Weapons:

None

Capsule: The YG-4210 light freighter, built by the Corellian Engineering Corporation, was a very old ship model, predating the famous YT series by several decades. Designed specifically for space exploration rather than combat, the freighter was originally unarmed. However, after centuries of serving, most likely none of them matched the original specifications. Weapons

such as blasters, ion cannons and concussion missiles were common in these modified vehicles.

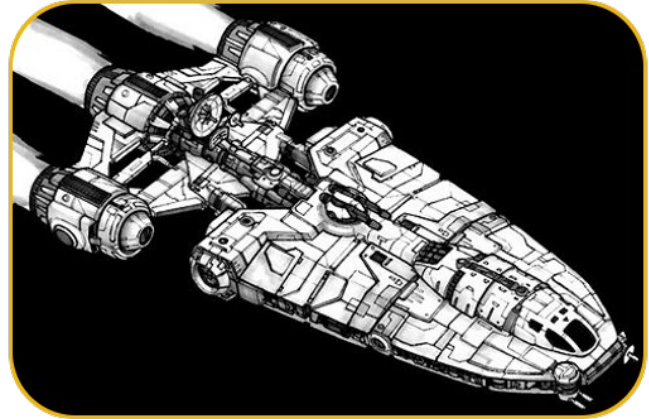

Addendum Personal- General Han Solo

No back-up drive, weapons or shields...trade in some of the living quarter space for cargo capacity and do some upgrades and this might not be a bad little ship...

CHAPTER 8

YL/YR/YU FREIGHTER

Freighters are not really my specialty, to be real honest about the matter; I was always more of a Starfighter kind of guy. I got into law-enforcement during my days when I lived on Corellia joining Corsec and eventually worked my way up through the ranks like my father, the infamous 'Hal Horn' who always told me being Corsec security meant having blood, guts and determination. As you can imagine it wasn't easy being the son of Hal Horn. We lived near the edge of 'Lowtown' and I made friends no matter where I went, but as soon as they heard I was the son of Hal Horn, well...thinks took a change in the friendship real fast and dirty.

I wanted to be a pilot, every youngling that grows up running the streets of Corellia wants to be a pilot and I was certainly no different than the other half a million or so children my age at the time. My mother wanted me to pursue some sort of career in art, maybe as a curator or as a critique perhaps even as an artist. There was just one small problem, while I can tell you who all the great Corellian artists are and from what time span they lived during the age of the Republic, I have no aptitude for art whatsoever. I love it, but my stick figures look like Wookiees set on fire. So with my art career as nothing more than a figment of my mother's imagination I made the decision when I was ten standard years old that I wanted to go off and join the Imperial academy to become a TIE-fighter pilot. Of course not knowing anything about why this might have been a bad idea, I had no understanding why my father had a meltdown over the decision. For those of you who have never met him, let me just give you some quick facts.

He was a highly respected commander at Corsec and when he gave an order, he didn't expect you to question it; he expected you to complete the order as it was given. There was no arguing about the matter and anything I might have tried to say would only have landed me in real trouble. However as a concession on the matter, my mother talked him into getting my piloting lessons on the condition that I picked a career of their choosing. Not wanting to be stuck as an art critique or museum set designer of some sort, I chose to follow my father into Law-Enforcement thinking that one day I could work my way up to the Corsec Planetary Defense Corps and be able to fly fighters. Instead I scored high enough coming out the Corsec academy and was shunted

into the Security force. The YL, YR and YU freighter lines were designed by a Drall named Dr. Insmooth Archam and while I can't seem to find out much about him, suppression of Drall achievements during the height of the Empire wasn't that uncommon, I was able to track down a quote about the lines that I thought I would mention here.

“My message is simply to have the courage to think differently, courage to invent, to traverse the unexplored, courage to discover the impossible and to conquer the problems and succeed. These are great qualities that must be worked towards. Do not go where the path may lead, go instead where there is no path and create a journey. For I believe that everything that we undertake is put in our path for a purpose. If you're willing to pay attention to the lessons we learn in life, trust in the force and not be afraid to take risks, then we will have made out on paths and undertaken out own journeys.”

- Dr. Insmooth Archam

In closing, I do have to agree with General Solo, I have no idea how you get the cargo down off of the YR-650...

**Corran Horn,
Colonel in the Republic Navy and heroic pilot in Rogue Squadron.**

YL-2200

LIGHT FREIGHTER

Craft: Corellian Engineering Corporation YL-2200

Type: Stock light freighter

Era: Rise of the Empire

Affiliation: General

Source: Galaxy Guide 3 – The Empire Strikes Back (page 88)

Scale: Starfighter

Length: 28.2 meters

Skill: Space transports: YL-2200

Crew: 1 (1 can coordinate), gunners: 1

Passengers: 6

Cargo Capacity: 100 metric tons

Consumables: 2 months

Cost: 100,000 (new), 25,000 (used)

Hyperdrive Multiplier: x2

Hyperdrive Backup: x12

Nav Computer: Yes

Space: 4

Atmosphere: 480; 800 kmh

Hull: 4D

Shields: 1D

Sensors:

Passive: 10/0D

Scan: 25/1D

Search: 40/2D

Focus: 2/3D

Weapons:

2 Laser Cannons

Fire Arc: Turret

Crew: 1

Scale: Starfighter

Skill: Starship gunnery

Fire Control: 2D

Space Range: 1-3/12/25

Atmosphere Range: 100-300/1.2/2.5 km

Damage: 4D

Capsule: The YL-2200 light freighter was a light freighter on the market around the time of the Battle of Hoth. It is known that the Rebellion made use of this craft. It required a crew of only one pilot, as well as a single gunner, and could transport six passengers. The YL-2200 could carry 100 metric tons of cargo. They cost 100,000 credits to buy new, and only 25,000 credits used. The YL-2200 could reach speeds of eight hundred kilometers an hour in atmosphere, and had a Class 2 Hyperdrive, with a Class 12 back-up. The vessels had a navigation computer and deflector shield generator installed, along with two laser cannons mounted on turrets.

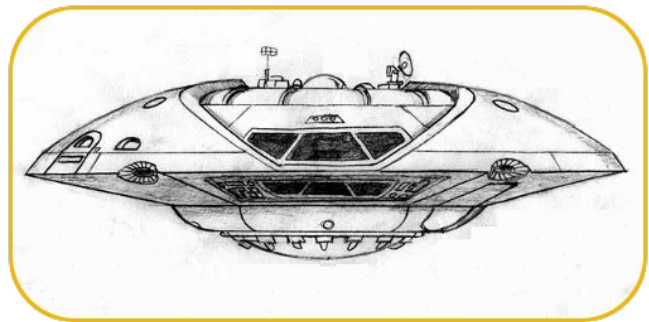

Addendum Personal- General Han Solo

I saw one of these during the battle of Hoth; you don't seem them around much and the least that I can say about it is that it's a functional enough ship, even if it has an odd shaped fuselage.

YR-650

CARGO HAULER

Craft: Corellian Engineering Corporation YR-650 Cargo Hauler

Type: Cargo hauler

Era: Rise of the Empire, Rebellion

Affiliation: General

Source: Arbitrary / Random-Homemade and appears to originate from RPGGAMER.org

Scale: Starfighter

Length: 21.2m

Skill: Space Transports - YR-650

Crew: 1

Crew Skill: varies

Passengers: 4

Consumables: 6 Months

Cargo Capacity: 20 Tons

Cost: 145,000 (new); 24,000 (used)

Hyperdrive Multiplier: x3

Hyperdrive Backup: None

Hyperdrive Backup: No

Nav Computer: Yes

Space: 4

Atmosphere: 450; 800 kmh

Maneuverability: 1D

Hull: 4D

Sensors:

Passive: 18/0D

Scan: 36/1D

Search: 54/2D

Focus: 2/3D

Weapons:

None

Capsule: The YR-650 is a cargo hauler, designed with upper cargo clamps which lock onto cargo pods of up to 1000 tons capacity, conceived to fill the gap between the YT series of transports and the larger bulk

transports. Although it is less capable than many other bulk transports and cargo haulers, the YR-650 is far more affordable, with its small internal cargo hold capable of handling some modifications while retaining the external cargo pods for transporting cargo itself. YR-650's are less common than many other cargo haulers due to their small size, and the corresponding small value of the cargo it can haul. The few that ply the space lanes are reliable and well liked vessels, which remain in production even though C.E.C. has been disappointed with their sales.



Addendum Personal- General Han Solo

Baay Shfat, what the hell is that thing? And how do you get the cargo pod down off the roof once you land?

YU-410

LIGHT FREIGHTER

Craft: Corellian Engineering Corporation YU-410
Light Freighter

Type: Light Freighter

Era: Old Republic

Affiliation: General

Source: Converted- Star Wars Gamer 2

Scale: Starfighter

Length: 44 meters

Skill: Space Transports: YU-410

Crew: 4+4 gunners

Crew Skill: Varies

Passengers: 12

Cargo Capacity: 250 metric tons

Consumables: 2 months

Cost: 200,000 (new), 80,000 (used)

Hyperdrive Multiplier: x2

Hyperdrive Back-Up: x12

Nav Computer: Yes

Maneuverability: 0D

Space: 4

Atmosphere: 280; 800 kmh

Hull: 4D+2

Shields: None

Sensors:

Passive: 10/0D

Scan: 25/1D

Search: 40/2D

Focus: 2/3D

Weapons:

4 Double Laser Cannons

Fire Arc: 2 in turrets, 2 in partial turrets
(front right, and front left)

Crew: 1

Scale: Starfighter

Skill: Starship Gunnery

Fire Control: 3D

Space Range: 1-3/12/25

Atmosphere Range: 100-300/1.2/2.5 km

Damage: 5D

Capsule: At 44 meters long, the YU-410 was relatively large for a light freighter, and could carry a fairly impressive 250 metric tons of cargo. It was also well armed, with four double laser cannon turrets, mounted on the upper and lower hull, these advantages came at a price, as the YU-410 was relatively slow and had very poor maneuverability. As part of cost-cutting, it was equipped with smaller than normal engines that led to a low maximum speed and reduced maneuverability. Like most C.E.C. designs, it was easily repaired and modified. The large cargo space was often converted in opulent living quarters, making the YU-410 into a mobile base of operations.

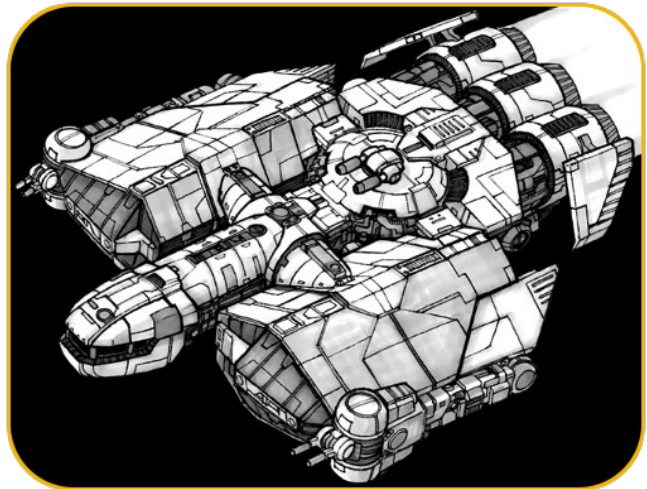

Addendum Personal- General Han Solo

Add some shields and maneuverability thrusters and this is a decent cargo ship...

CHAPTER 9

SCOUT SHIPS

It all started with Han Solo.

I had already been an established bounty hunter with a decent reputation when I got into swoop racing, in retrospect I was always looking for bigger and better challenges and having already mastered the professional circuit on Corellia, I decided to take on the private circuit. It was higher stakes and faster swoops without all the regulations and safety requirements that come with the professional circuit; that is to say it was ran by Hutts, Jabba specifically, and I was looking to find be thrills, yet another pretty girl and some credits to make ends meet.

So there I was on Agrilat when I heard about this hot shot racer named 'Solo'. Now to be honest it might have been before the Kessel Run he is always bragging about, but I couldn't tell you and honestly don't give a womprat's backside. So there we were on Agrilat, at the Crystal swamp course, and I get a good look at this kid and figure that I can take him in the race, score big and walk off with the credits. It seemed to me that as much as he ran off at the mouth that he was just all talk and y'know the saying about 'credits talk and bantha poodoo walks, right? So I figure that it's easy, peasy Hapanesey...right?

Wrong.

I'm gonna admit something here, something that I never admitted before now either in print, on the holonet or to another living being. This is something that took me years to come to and realize, but here it is.

While I was injured in the race and Han Solo was there, it was entirely my fault. I saw him coming up behind me and he gunned his engine off of a mound of crystals making this six meter leap into the air and I just knew that if I gunned the engine that I could get ahead of him. But I didn't and instead I was caught in the backwash of his engine setting myself on fire when he all but landed on top of me, the look of horror on his face as he fought to break the swoops apart as I screamed in agony is something that I will never forget. I spent a lot of years hating him and wanting to kill Solo, which I am told is not something that is all that uncommon if

you know him for long enough...I got my life straightened out and eventually the cybernetics removed and settled down with a nice girl from named Manaroo on a backwater planet named Tatooine. She got me into some therapy and after a long time I was able to let go of most of the anger and hatred towards Solo, I even once helped his kids with something they were up to. So since I am getting a few credits to talk about the Corellian Engineering Corporations couple of scout ships, I figures I'd drop in my opinion on the matter

"I've actually owned both at various points in my career as a bounty hunter and while I enjoyed the YSS-01 for its superior shield strength, the JM-5000 is a far better craft with more engine power and while the maneuverability thrusters aren't as good it suited my needs perfectly. In terms of space the commentary made by Han Solo is correct, the YSS model is bigger with more space, but the JM-5000 allows you to handle your...acquisitions...a lot easier. Weapon modifications made at the sacrifice of cargo space make the JM-5000 a truly deadly threat to behold..."

**—Dengar,
Corellian bounty hunter and proud owner of *The Punishing One*.**

JM-5000

JUMPMASTER

LONG RANGE SCOUT

Craft: Corellian Engineering JumpMaster 5000

Type: Scout Ship

Era: Rise of the Empire, Rebellion

Affiliation: General

Source: Converted-Edge of the Empire p.256

Scale: Starfighter

Length: 20.1 meters

Skill: Space Transports: JumpMaster 5000

Crew: 1 Pilot/Gunner

Crew Skill: Skills vary widely.

Passengers: 1

Cargo Capacity: 50 metric tons

Consumables: 2 months

Cost: 155,000(new), 45,000 (used)

Hyperdrive Multiplier: x3

Hyperdrive Backup: x15

Nav Computer: Yes

Maneuverability: 1D+2

Space: 8

Atmosphere: 415; 1,200 kmh

Hull: 4D

Shields: 1D

Sensors:

Passive: 30/0D

Scan: 50/1D

Search: 75/2D

Focus: 5/3D

Weapons:

2 Light Laser Cannon (fire-linked)

Fire Arc: Turret

Crew: 1

Scale: Starfighter

Skill: Starship gunnery

Fire Control: 2D

Space Range: 1-3/12/25

Atmosphere Range: 100-300/1.2/2.5 km

Damage: 4D+2

Capsule: Corellian Engineering's JumpMaster-class long range scouts are small, one-person vessels designed for long-range scouting and reconnaissance. Relatively fast and agile, JumpMaster have a flat, roughly crescent-shaped hull packed with the ship's powerful and sensitive sensor systems. An offset, cylindrical pod located to starboard of the ship's centerline houses the cockpit, the pilot's small and spartan quarters, and the ship's power generators and drive system. Lightly armored and carrying only a twin light laser cannon, JumpMasters rely on their speed and sensors to avoid trouble. JumpMasters serve in many planetary militaries as picket ships and early warning patrol craft within star systems. Their primary use, however, is the galaxy's Civilian Astrogation Corps, the volunteer group of explorers, astrogators, and cartographers responsible for keeping hyperspace navigation charts up to date.



Addendum Personal- General Han Solo

The '5000 isn't a bad ship, but hardly useable as a cargo hauler, yeah it has a fifty ton capacity, but if you've ever been inside one you'd know it's as spacious as my bother-in-law's older speeder on Tatooine...

YSS-01

SCOUT

Craft: Corellian Engineering Corporation YSS-01
Deep Space Scout

Type: Scout

Era: Rise of the Empire, Rebellion

Affiliation: General

Source: Arbitrary / Random-Homemade and appears to originate from RPGGAMER.org

Scale: Starfighter

Length: 19m

Skill: Space Transports - YSS-01

Crew: 1

Crew Skill: varies

Passengers: 3

Consumables: 2 Years

Cost: 120,000 (new), 33,000 (used)

Cargo Capacity: 40 Tons

Hyperdrive Multiplier: x1

Hyperdrive Backup: x8

Nav Computer: Yes

Space: 4

Atmosphere: 480; 800 kmh

Maneuverability: 2D+1

Hull: 5D

Shields: 2D

Sensors:

Passive: 30/0D+2

Scan: 55/1D+1

Search: 80/2D+2

Focus: 3/3D+2

Weapons:

Twin Laser Cannons (fire-linked)

Fire Arc: Front

Crew: 1

Scale: Starfighter

Skill: Starship Gunnery

Fire Control: 2D

Space Range: 1-3/12/25

Atmosphere Range: 100-300/1.2/2.5 km

Damage: 6D

Capsule: The YSS-01 scout was an attempt by the Corellian Engineering Corporation to enter the lucrative scout ship market, and although the vessel was not much more than a modified light freighter, it still met with moderate success, but not enough to merit a follow up. The YSS-01 has a set of powerful sensors, and a good Hyperdrive while maintaining enough spare room for modifications to its sublight drive. While sharing features with the successful YT series of freighters, the YSS-01 is much smaller, actually coming out not much larger than some heavy fighters, which has led to some secondary market success as a shuttle.



Addendum Personal- General Han Solo

The '01 doesn't look half bad as far as specs go; I'd like to see what the deckplan looks like...

CHAPTER 10

YV FREIGHTERS

I really don't know General Solo all that well, while he was running around as a smuggler long, long ago I was working my way up through the ranks as a bounty hunter out on the outer rim territories in hot spot touristy exotic locations like Kilkebacin and Tatooine. We met over a the cards of a Sabacc game that Lando Calrissian was running out of the backroom of Nar Shaddaa eatery that he had some sort of vested interest in. I'm not sure if Lando was the owner, a partial owner or if someone just owed him a favor. But there we were and by we I mean Solo, Lando, Rik Duel, myself and Salla Zend playing Sabacc, my pal Trep Winters was drinking Corellian ale with Chewbacca while trying to learn Shyriiwook and you can imagine how well something like that went...

The game went well and we all had a lot of fun until Salla threw the flaming green vanarx in Rik Duel's lap after he made a less the sociable suggest about she could sit at the table. Personally I think that Rik had a few to many Corellian ales and was playing well out of his league, but who am I to say? The game came to an end when Chewbacca threw Rik out of the backroom and into an adjacent alley and that pretty much covers how I met Han Solo years and years ago.

Now as a freighter captain and eventually a 'free trader', which turned out to be more profitable then bounty hunting, I managed to get my hands on the one of the YT-1300 Nerfworks droid freighters and after some tinkering around her personality matrix finally revealed itself during a particularly dangerous space battle. I'm glad I have *Kierra*, don't get me wrong, but the idea of a droid brain slaved into a ship, if not monitored and maintained correctly, can be extremely dangerous. Which is of course while the Nerfworks was shut down...But I'm not here to talk to you about the Nerfworks, I'm here to talk to you about the YV-freighter line.

The YV-freighter was supposed to replace the YT-line allowing them to be phased out and for a new niche market to be discovered for the Corellian Engineering Corporation to plunder for untold riches. Sadly the line of ships failed miserably due to a number of design flaws or so I am told. When the sales numbers started coming in, someone got the bright idea of putting a disc shaped pod on some of the later models, but by then it was too late and the sales of the previous

ships caused the cancelation of the line altogether. The ships were designed by the late Kowen Ctesphens, his disappearance from public life makes me wonder who exactly he made so angry or if the Imperials were somehow behind his disappearance. Regardless, here are a few words from the man about the failure of the YV-series to find its place in the market...

"The failure of the YV-series doesn't come as much of a surprise to me, due to internal bickering, a lack of holonet sales ads and governmental interference I just knew that we would never find our place on the market. This is extremely sad, due in part to the stagnant nature in which the C.E.C. has been run over the last two hundred years of operation. We could have blown the dust off of this place and aired it out a little bit and instead I am being forced to resign, due to a lack of 'productivity', funny how that works after I worked diligently developing eight freighters for the C.E.C...."

–Kowen Ctesphens.

Powerful words about how the C.E.C. has treated some of the people that worked for them...

**Thaddeus Ross,
'Free Trader' and proud owner of *The Kierra*.**

YV-100 LIGHT FREIGHTER

Craft: Corellian Engineering Corporation YV-100

Type: Light freighter

Era: Rise of the Empire

Affiliation: General

Source: Converted- Star Wars Gamer 2

Scale: Starfighter

Length: 46.5 meters

Skill: Space transports: YV-100

Crew: 2

Crew Skill: Varies

Passengers: 10

Cargo Capacity: 150 metric tons

Consumables: 6 months

Cost: 150,000 (new), 50,000 (used)

Hyperdrive Multiplier: x3

Hyperdrive Backup: x12

Nav Computer: Yes

Maneuverability: 1D

Space: 6

Atmosphere: 330; 950 kmh

Hull: 5D

Shields: 1D

Sensors:

Passive: 10/0D

Scan: 25/1D

Search: 40/2D

Focus: 2/3D

Weapons:

2 Blaster Cannons (fire-linked)

Fire Arc: Partial Turret (front, right, left)

Crew: 1

Scale: Starfighter

Skill: Starship gunnery

Fire Control: 2D

Space Range: 1-3/12/25

Atmosphere Range: 100-300/1.2/2.5 km

Damage: 4D+1

2 Laser Cannons (fire-linked)

Fire Arc: Front

Crew: 1

Scale: Starfighter

Skill: Starship gunnery

Fire Control: 2D

Space Range: 1-3/12/25

Atmosphere Range: 100-300/1.2/2.5 km

Damage: 5D+1

Capsule: The YV-100 light freighter was the first of the Corellian Engineering Corporation's YV series starships released in the era surrounding the rise of the Galactic Empire. Its 46.5-meter-long frame housed enough room to hold 150 cubic meters of cargo, as well as other vital starship systems, including the Hyperdrive, weaponry, and living arrangements. On the exterior, the ship resembled C.E.C.'s YT series line in the rear portion—this design feature was due to the influence of the popular YT series already on the market which the designers brought along. The body also featured a long, slender forward portion—a feature that would become trademark to the future ships of the YV series.

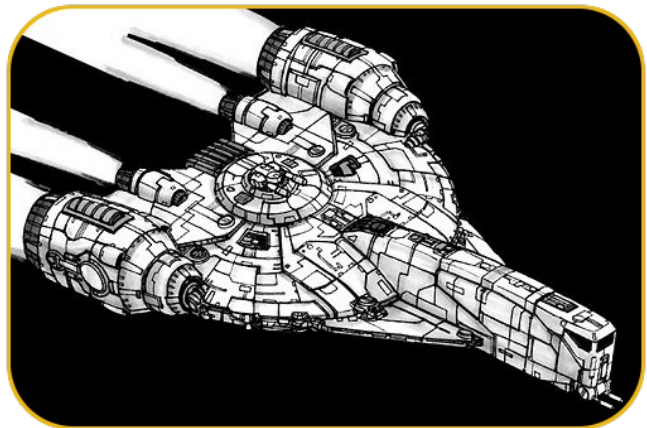

Addendum Personal- General Han Solo

Well-armed, decent cargo, maneuverability and shields and at a reasonable price. This one isn't half bad... Other than being HUGE, this one isn't too bad.

YV-260

TRANSPORT

Craft: Corellian Engineering Corporation YV-260 Transport

Type: Light freighter

Era: Rebellion

Affiliation: General

Source: Converted-Tempest Feud (page 125)

Scale: Starfighter

Length: 41.5 meters

Skill: Space transports: YV-260

Crew: 2, gunners: 2, skeleton: 1/+5

Crew skill: Varies widely

Passengers: 8

Cargo Capacity: 140 metric tons

Consumables: 3 months

Cost: 140,000 (new), 83,000 (used)

Hyperdrive Multiplier: x1

Hyperdrive Backup: x10

Nav Computer: Yes

Maneuverability: 1D

Space: 6

Atmosphere: 330; 950 kmh

Hull: 4D

Shields: 2D

Sensors:

Passive: 10/+1

Scan: 30/1D

Search: 45/2D

Focus: 3/3D

Weapons:

2 Blaster Cannons (fire-linked)

Fire Arc: Front

Crew: 1

Scale: Starfighter

Skill: Starship gunnery

Fire Control: 2D

Space Range: 1-3/12/25

Atmosphere Range: 100-300/1.2/2.5 km

Damage: 5D

Capsule: The YV-260 light freighter was a freighter manufactured by Corellian Engineering Corporation. It measured 41.5 meters in length, and was produced during the last years of the Galactic Republic. One YV-260 freighter was Vengeance, which was one of several similarly modified Corellian YV-260 freighters operated by a pirate fleet in the Corporate Sector.

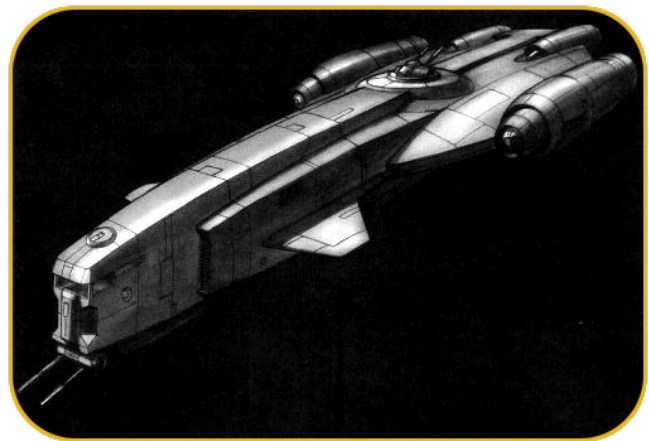

Addendum Personal- General Han Solo

This is another ship that isn't half bad, the problem with long, narrow ships like this is that if there aren't proper armament placements for defense the pilot and crew get caught broad-sided with their only hope being that they can keep the deflector shields up and running long enough to turn around or that their engines don't get damaged so they can't run like hell...

YV-330

TRANSPORT

Craft: Corellian Engineering Corporation YV-330 Transports

Type: Light freighter

Era: Rebellion

Affiliation: General / CorSec

Source: Converted- Star Wars Gamer 2

Scale: Starfighter

Length: 26 meters

Skill: Space transports: YV-330

Crew: 2, gunners: 2, skeleton: 1/+5

Crew skill: Varies widely

Passengers: 6

Cargo Capacity: 20 metric tons

Consumables: 2 months

Cost: 100,000 (used)

Hyperdrive Multiplier: x2

Hyperdrive Backup: x12

Nav Computer: Yes

Maneuverability: 2D

Space: 6

Atmosphere: 330; 950 kmh

Hull: 5D

Shields: 2D

Sensors:

Passive: 10/+1

Scan: 25/1D

Search: 40/2D

Focus: 2/3D

Weapons:

2 Twin Laser Cannons

Fire Arc: Turret

Crew: 1

Scale: Starfighter

Skill: Starship Gunnery

Fire Control: 3D

Space Range: 1-3/12/25

Atmosphere Range: 100-300/1.2/2.5 km

Damage: 5D

Capsule: The YV-330 light freighter was a YV series light freighter produced by the Corellian Engineering Corporation. It was 26 meters long, and its standard armament was a twin laser cannon turret mounted beneath the cockpit. YV-330 freighters were often used by smugglers, and modified with heavier weaponry. The YV-330 was usually used by the Corellian Security Forces for patrol and customs operations, and the ship is truly more than a match for smugglers and pirates. The ship's main hull was separated in an engine and crew section which was rather small and didn't leave much space for passengers or even cargo. Most of the space was needed for the crew quarters and gun wells, of which the ship had plenty.

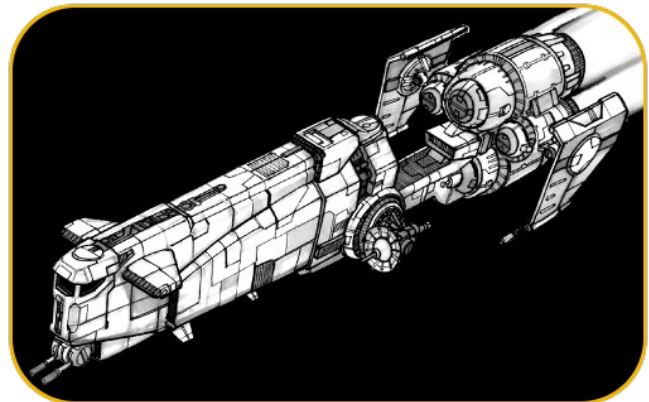

Addendum Personal- General Han Solo

The C.E.C. likes to play their own jizz-tune when it comes to the '330 and how the Corellian Security Forces used the ship to route smugglers and free traders making Corellia safe for everyone. I've heard too many stories of firefights where the offending party got off a lucky shot and blew out the connecting corridor to the engineering section and what's worse, and not mentioned in the official specs is that the environmental sealants do not react fast enough to this pressure loss...

YV-545

TRANSPORT

Craft: Corellian Engineering Corporation YV-545 Transport

Type: Space transport

Era: Rebellion

Affiliation: General

Source: Converted-Rebellion Era Sourcebook (pages 14-15)

Scale: Starfighter

Length: 32 meters

Skill: Space transports: YV-545

Crew: 2

Crew Skill: Varies

Passengers: 8

Cargo Capacity: 100 metric tons

Consumables: 2 months

Cost: 45,000 (used)

Hyperdrive Multiplier: x2

Hyperdrive Backup: x12

Nav Computer: Yes

Maneuverability: 1D

Space: 8

Atmosphere: 360; 1,000 kmh

Hull: 5D

Sensors:

Passive: 10/0D

Scan: 25/1D

Search: 40/2D

Focus: 2/3D

Weapons:

2 Heavy Ion Cannons (fire-linked)

Fire Arc: Turret

Crew: 1

Scale: Starfighter

Skill: Starship gunnery

Fire Control: 2D

Space Range: 1-3/7/36

Atmosphere Range: 100-300/700/3.6 km

Damage: 5D

Capsule: The YV-545 light freighter was a light freighter produced by the Corellian Engineering Corporation in an attempt to replace the aging YT series freighters. The YV-545 had a cylindrical hull, with the cockpit mounted to the side like most C.E.C. designs. The YV-545 was considered to be sturdier and more maneuverable than the YT-series vessels, though lacked the visual appeal of the YT-1300 light freighter. In flight the cockpit rotated 90 degrees to be on top of the starship, while the body remained beneath. Though the ship could land in this configuration as well, most buyers saw this design as too complex. Its body was ringed by sensors and maneuvering thrusters, which gave it exceptional maneuverability. It could rival most Starfighters in performance and was a popular ship with smugglers and pirates, who liked to modify the YV-545 into an attack ship.



Addendum Personal- General Han Solo

The '545 is a decent enough ship, the only problem that I've ever heard anyone mention about it comes from the cockpit being able to rotate like it does. I know a couple of freighter captains whose cockpit got jammed during or after rotation. The entrance way to the flight deck irises shut so you can just imagine the hassle of trying to get out after something like that happened.

YV-664 LIGHT FREIGHTER

Craft: Corellian Engineering Corporation YV-664 Light Freighter

Type: Space transport

Era: Rebellion

Affiliation: General

Source: Fanmade-Star Wars Trading Card Game – A New Hope (Card: YV-664 Light Freighter)

Scale: Starfighter

Length: 40 meters

Skill: Space transports: YV-664

Crew: 2, gunners: 1

Crew Skill: Varies

Passengers: 10

Cargo Capacity: 130 metric tons

Consumables: 3 months

Cost: 120,000 (new), 40,000 (used)

Hyperdrive Multiplier: x2

Hyperdrive Backup: x15

Nav Computer: Yes

Space: 7

Atmosphere: 350; 950 kmh

Hull: 5D

Sensors:

Passive: 10/0D

Scan: 30/1D

Search: 40/2D

Focus: 2/3D

Weapons:

Laser Cannon

Fire Arc: Turret

Crew: 1

Scale: Starfighter

Skill: Starship gunnery

Fire Control: 2D

Space Range: 1-3/12/25

Atmosphere Range: 100-300/1.2/2.5 km

Damage: 4D+2

Capsule: The YV-664 light freighter was a modern light freighter model produced by the Corellian Engineering Corporation. It was regarded by many as having a good balance of cargo capacity, durability, and speed. The ship had the saucer-like shape of the YT series, giving it the ability to move around easily. The YV-664 had many similarities to the YT-1300 light freighter, such as the cockpit style and engine configuration, though a few differences from past models existed.

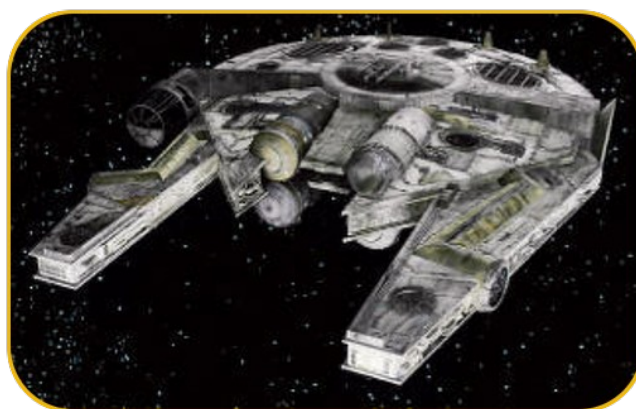

Addendum Personal- General Han Solo

I ain't ever seen a '664 before now and with the lack of shields, I know the first thing I'd modify if I ever had to buy one...Just a friendly word of advice when it comes to buying your own ship, always look at what it is going to cost you to modify anything you buy. 'Used' isn't a dirty word, as a matter of fact it can be your best friend.

YV-666 LIGHT FREIGHTER

Craft: Corellian Engineering Corporation YV-666
Light Freighter

Type: Light freighter

Era: Galactic Republic

Affiliation: General

Source: +Oliver Queen

Scale: Starfighter

Length: 41 meters

Skill: Space transports: YV-666

Crew: 1, gunners: 1

Passengers: 4

Cargo Capacity: 20 metric tons

Cost: 480,000 (new)

Hyperdrive Multiplier: x2

Backup Hyperdrive: x12

Nav Computer: Yes

Consumables: 6 months

Maneuverability: 1D+2

Space: 7

Speed: 350; 1,000 kmh

Hull: 4D

Shields: None

Sensors:

Passive: 10/0D

Scan: 25/1D

Search: 40/2D

Focus: 2/4D

Weapons:

Heavy Blaster Turret

Fire Arc: Turret

Crew: 1

Scale: Starfighter

Skill: Starfighter gunnery

Fire Control: 1D

Space Range: 1-5/10/17

Atmosphere Range: 100-500/1/1.7 km

Damage: 4D

Game Notes: Maneuvering Fins: in atmosphere Maneuver-

ability: 2D+1.

Capsule: Another design brought to life by Corellian engineers, the YV-666 is considerably larger than its smaller and cheaper counterparts. The ship sports a long, tall, blocky main hull with port and starboard maneuvering fins to the rear of the craft for vertical movement. A decent all-round ship, the YV-666 manages to retain the legendary ease of modification usually prevalent in smaller freighters. As with most of the YV series, the YV-666 is built around a two deck main hull. The top deck houses the bridge and navigation systems, while the bottom deck is devoted to engines, power cores, weapons systems and storage bays. The main deck, arguably the major selling point of the ship, is capable of housing both vehicles and fighters. The holds are large enough that one trader claimed he found it could fit a personal residence with room to spare for his speeder. As such, many pirates use the YV-666 as escort carriers on supply raids. Nevertheless, the ship's light armament puts it at something of a disadvantage when faced with better armed customized merchant frigates. Overall, the YV-666 features a simple but admirably effective propulsion system, providing considerable maneuverability, as well as decent hyperspace and sub light speeds despite its size.



Addendum Personal- General Han Solo

Limited cargo space and no shields don't make the '666 a decent cargo hauling vessel; on the other hand if you were a bounty hunter looking to transport your captured prey then this might work out well for you, assuming of course that cost isn't really a factor...Little known fact, Bossk the Trandoshan bounty hunter actually stole his '666 from a bounty he captured. He liked to tell people that as a successful hunter he made the creds needed to buy his ship outright, that of course is a lie, but then again what can you expect from someone who slaved wookiees to 'make his rep'?

YV-700

ARMED TRANSPORT

Craft: Corellian Engineering Corporation YV-700 Armed Transport

Type: Armed transport

Era: Rise of the Empire, Rebellion

Affiliation: General

Source: Arbitrary / Random-Homemade and appears to originate from RPGGAMER.org

Scale: Starfighter

Length: 25m

Skill: Space Transports - YV-700

Crew: 1 + 1 Gunners

Crew Skill: varies

Passengers: 10

Consumables: 1 Year

Cargo Capacity: 60 Tons

Cost: 35,000 (used)

Hyperdrive Multiplier: x1

Hyperdrive Backup: x10

Nav Computer: Yes

Space: 5

Atmosphere: 520; 900 kmh

Maneuverability: 2D+2

Hull: 4D+1

Shields: 2D

Sensors:

Passive: 30/1D

Scan: 60/2D

Search: 90/3D

Focus: 2/4D+2

Weapons:

Twin Medium Laser Cannons

Fire Arc: Turret

Crew: 1

Scale: Starfighter

Skill: Starship Gunnery

Fire Control: 2D

Space Range: 1-3/15/25

Atmosphere Range: 100-300/1.5/2.5 km

Damage: 6D

Capsule: Although the YV-700 is called an "Armed Trans-

port" it was really designed as a custom vessel for Bounty Hunters, and is an adaptation of the YV-666 which was already popular with the Bounty Hunter community. The engines could twist through 90 degrees, allowing the vessel two flight modes, although it was mainly designed to fly in its upright mode, and to land as a more conventional vessel, this design feature was heavily borrowed from the Fire-spray class of vessel which was also very popular with Bounty Hunters. The YV-700 has a decent sized cargo bay, which is usually modified into luxurious living quarters, holding tanks, or just used to contain the massive modifications that Bounty Hunters usually make to their vessels, however the vessel isn't too highly priced for a transport ship and many have been purchased and are used in territory where a fast, well-armed transport vessel is a near necessity.



Addendum Personal- General Han Solo

You'll notice that the C.E.C. will go wherever the market needs take them, not content to sell to just freighter captains they are more than willing to design an entire line of ships just for the exclusive use of bounty hunters. This one borrows, and I use that word lightly, everything from the Fire-spray class vessels in an effort to appeal to all the bounty hunters who want to be 'the next Boba Fett', that's all good and fine until someone drops you into a man-eating pit on some desert planet in the outer rim...

YV-929

ARMED FREIGHTER

Craft: YV-929 Armed Freighter

Type: Light Freighter

Era: Rise of the Empire, Rebellion

Affiliation: General

Source: Converted- Star Wars Gamer 2.

Scale: Starfighter

Length: 22 meters

Skill: Space Transports: YV-929

Crew: 1+3 gunners

Crew Skill: Varies

Passengers: 6

Cargo Capacity: 150 metric tons

Consumables: 3 months

Cost: 250,000 (new), 100,000 (used)

Hyperdrive Multiplier: x2

Hyperdrive Back-Up: x12

Nav Computer: Yes

Maneuverability: 1D

Space: 5

Atmosphere: 350; 1000 kmh

Hull: 1D

Shields: 4D

Sensors:

Passive: 10/0D

Scan: 25/1D

Search: 40/2D

Focus: 2/3D

Weapons:

2 Double Turbolaser Cannons (fire-linked)

Fire Arc: Front

Crew: 1

Scale: Starfighter

Skill: Starship Gunnery

Fire Control: 2D

Space Range: 1-5/15/20

Atmosphere Range: 100-500/1.5/2 km

Damage: 5D+1

2 Ion Cannons (fire-linked)

Fire Arc: Partial Turret (front, left, right)

Crew: 1

Scale: Starfighter

Skill: Starship Gunnery

Fire Control: 2D

Space Range: 1-3/7/36

Atmosphere Range: 100-300/700/3.6 km

Damage: 4D+1

2 Triple Blasters (fire-linked)

Fire Arc: Front

Crew: 1

Scale: Starfighter

Skill: Starship Gunnery

Fire Control: 3D

Space Range: 1-5/10/17

Atmosphere Range: 100-500/1/1.7 km

Damage: 4D+2

4 Twin Concussion Missile Launchers

Fire Arc: 2 front, 2 rear

Crew: 1

Scale: Starfighter

Skill: Projectile Weapons: Concussion Missiles

Fire Control: 1D

Space Range: 1/3/7

Atmosphere Range: 50-100/300/700

Ammo: 10 salvos each

Damage: 9D (each missile)

Capsule: The YV-929 armed freighter was a 22-meter-long light freighter produced by Corellian Engineering Corporation. It used the same forward cockpit structure as the much larger YV-100 light freighter. Unlike most C.E.C. freighters, which came off the assembly lines with minimal weaponry, the YV-929 was designed from the start to be heavily armed for defense against pirate and Rebel raids, and also featured very strong shields. The YV-929 was armed with two dual light turbo lasers, dual ion cannon turret beneath the cockpit, two triple blasters mounted on stubby wings, and four concussion missile launchers, half of which

YV FREIGHTERS

fired to the aft. Despite its compact size and heavy armament, the YV-929 was still able to carry 150 metric tons of cargo. Not surprisingly, the YV-929 was often used by the very Rebels and pirate groups it was designed to defend against. The second most common user of the design was the Corporate Sector Authority. It was often referred to as a "flying brick". The Empire often sanctioned or fined C.E.C. for selling the freighters to various third parties such as the Rebel Alliance. A variant of the YV-929 was produced which reduced the armaments by removing the turbolasers and one of the concussion missile launchers. This version of the craft carried enough consumables for six months of operation.

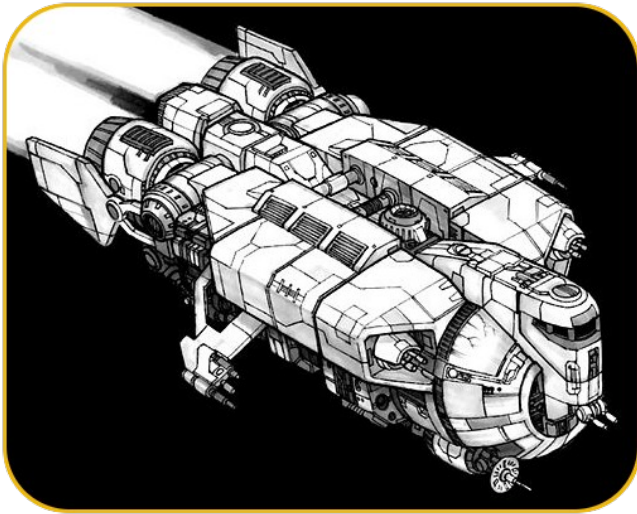

Addendum Personal- General Han Solo

Baay Shfat, leave it to the C.E.C. to create a gunboat like this, but to skimp on the hull rating. I don't care how strong your shield generator is, if it gets blown during a fight that hull will rupture without even the most basic ray shielding...

CHAPTER 11

YX FREIGHTERS

I've known Han Solo for most of his life.

Before the time when Garris Shrike took him in and while Han was forced to work for that *Fa'gine* I was his friend and principal protector as best I could be, it was I that taught Han Solo in the arts of hand to hand combat and over saw his safety as best I could until I was exiled from Shrike's group and Han forcible removed from my life. Despite that fact we did see one another again over time and while our friendship was there and continued on even into adulthood, something had changed. Perhaps there was too much time apart or maybe like most childhood friendships we simply drifted apart only to become familiar faces from the past simply haunting the present, such as it was at that time.

Before my time in the New Republic Intelligence community, I wandered the universe seeking my place in it. For you see while I was born on Corellia and my father was Corellian by birth, my mother was Nagai and I was treated with less respect than one would give to a canine. In dwelling on this matter I decided to leave Corellia and seek my fortune and destiny among the stars, this wasn't nearly as much fun as one might expect it to have been. I worked on various freighter ships making my way through the galaxy, I traveled from one end to another and when I thought I could stand it no more I went a little further and found myself working as part of a crew on an YX-Freighter heading into the *Unknown Regions*, the captain of the '*The Fool's Luck*' had hoped to make some credits trading with unknown races in the '*Regions*', what occurred was an unfortunate chain of events.

We were set upon by a Chiss battle fleet and the freighter was shot out from under us, the Captain as well two of the crew members and I were able to jettison in an escape pod and it was through the grace of the Force that we made planet fall. As it turned out the planet was JoDuf'tain my mother's home planet and where I eventually found her. I will spare you the details of that story as it doesn't relate much to the notion of traveling on an YX-Freighter...

While on the vessel the Captain told me what he knew of the history of the YX-freighter class...

"It was a spacious ship designed to ferry large loads of cargo, and like the YT-freighters it was designed to be modularly engineered so that if necessary the crew could arrange the layout in a fashion that was best for them to get the maximum utilization of space out of its vast cargo stores. The big downside to it of course was that when they designed the thing, they didn't bother to make it very maneuverable or put any sort of defensive weaponry on board. The strange part is that I heard a rumor that the original prototype had some sort of hyper drive malfunction and that the vessel, crew and all including its designer Doctor Nhoj Robe'sun were lost..."

—Captain Illam Momea.

After hearing that story I would often lay in my bunk and wonder whatever became of the crew of that missing freighter, did they make a life for themselves trapped somewhere far, far from home or were they simply swallowed up by universal forces and never seen again? I guess that we'll never know what truly happened to them. I did make it back from JoDuf'tain and rejoined the known galaxy lending my services once more to the Rebellion against the empire and found myself reunited with my adopted brother Han Solo. It seemed more like a homecoming than getting to JoDuf'tain did...

**Bey,
Corellian/Nagai hybrid and one time winner of the Blood
strip for bravery.**

YX-2000 MEDIUM FREIGHTER

Craft: Corellian Engineering Corporation YX-2000 Medium Freighter

Type: Stock Medium Freighter

Era: Rise of the Empire, Rebellion

Affiliation: General

Source: Arbitrary / Random-Homemade and appears to originate from RPGGAMER.org

Scale: Starfighter

Length: 50 meters

Cost: 300,000(new); none available used (yet)

Skill: Space Transports: YX-2000

Crew: 1 to 3 (can coordinate)

Passengers: 1

Cargo Capacity: 1,500 metric tons

Consumables: 3 months

Hyperdrive Multiplier: x3

Hyperdrive Backup: x20

Nav Computer: Yes

Maneuverability: 0D

Space: 5

Atmosphere: 200; 540 kmh

Hull: 4D

Shields: 1D

Sensors

Passive: 12/0D+2

Scan: 30/1D

Search: 60/2D+2

Focus: 3/4D

Capsule: The C.E.C.'s newest freighter. It was designed after a successful prototype run. Of course, it is highly modifiable, but whether or not it is successful remains to be seen. This freighter is one of the few highly quality ships produced by Corellians in light of their recent local paranoia and xenophobia. It was released shortly after the Battle of Yavin, but sales are re-

portedly low.



Addendum Personal- General Han Solo

I've never seen one of these or even heard of one before reading these specs and frankly I'm having trouble believing that the ship even exists...It looks and sounds like someone's pipe dream for a ship.

CHAPTER 12

YZ FREIGHTERS

In all my years in the Rebellion forces during the many skirmishes that we fought across the known galaxies, I can tell you for certain that we never had any ships like these in our fleets.

Oh I wish that we had dozens in fact, but with the resources we were able to scrape together and after defecting to a group of Rebels on Tython I realized just how under staffed, over worked and just plain out gunned the Rebellion forces were at the time. It was partially my idea to get starship thieves to swipe anything that wasn't locked into place at whatever shipyards they could get into. Privateers, like the dread pirate Messina Kellor working in the Ison Corridor, were given funding and a generous cut of anything they procured, but only if we got to kurosawa pick from the weapons and ships taken. The Corellian Engineering Corporation can tell the story that these ships were around during the war and I am sure that they existed, but I can tell you that *I* never had the chance to use battleships of this capacity; General Solo is right in his assessment of the vessels. *If we had had them during the war, it would have ended a whole lot sooner...*

I will point that despite the fact that the Corellian Engineering Corporation routinely denies that they originally designed these vessels for combat use and often times tries to justify their creation by saying that they are nothing more than simple freighter class vessels that have been modified by unscrupulous owners the vehicles lend themselves with relative easy to combat and are, with very simple modifications combat ready in a relatively short amount of time. It goes without saying that in the aftermath of the war, the Republic did in fact get some use out of the YZ-freighters, but it mostly happened in the aftermath of Grand Admiral Thrawn's attacks, near a bouts 5 ABY...In the time since then though we have but the vessels to moderate use, although we did run into some trouble with the Coynites over what they perceived was a design theft where the YZ-785 was concerned. As far as I know the Corellian Engineering Corporation has the matter tied up in the courts as of this printing...

Admiral Akbar, who is usually very stoic and a being of few words had this to say about the YZ-freighter class and their being used in by the Rebellion during the way...

“Son of a Sith Harlot and by all the infinite oceans of Dac, It's too good to be true and must be a trap!”

—Admiral Gial Akbar, Supreme Commander of the Rebellion and New Republic Forces.

As far as anyone could tell the freighter class was designed and built through the guidance of Dr. D.W. Jiker, a Corellian born from wealth and power, the son of famed weapons manufacturer W.D. Jiker the XVI, one time owner of Thorlarkton Firearms manufacturing on Corellia. This is the family that tried to go up against the 'Blastech Firearms' family and lost big when Thorlarkton Firearms was seized by the Imperials for violations of the Palpatine Act, whatever that was...The last anyone heard Dr. D.W. Jiker was taken into custody shortly after the battle of Hoth and sent to a 'reeducation' center near the galactic rim, I'm not sure what ever became of him after that...

**General Crix Madine,
Supreme Commander of Alliance Special Forces.**

YZ-775

TRANSPORT

Craft: Corellian Engineering Corporation YZ-775
Transport

Type: Light Freighter

Era: Rise of the Empire, Rebellion

Affiliation: General

Source: Converted-Star Wars Gamer 2

Scale: Starfighter

Length: 52 meters

Skill: Space Transports: YZ-775

Crew: 8

Crew Skill: Varies

Passengers: 14

Cargo Capacity: 400 metric tons

Consumables: 6 months

Cost: 500,000 (new), 350,000 (used)

Hyperdrive Multiplier: x1

Hyperdrive Back-Up: x12

Nav Computer: Yes

Maneuverability: 1D

Space: 6

Atmosphere: 330; 950 kmh

Hull: 7D

Shields: 6D

Sensors:

Passive: 10/0D

Scan: 25/1D

Search: 40/2D

Focus: 2/3D

Weapons:

2 Turbolaser Cannons (fire-linked)

Fire Arc: Partial Turret (front, right, left)

Crew: 3

Scale: Capital

Skill: Capital Ship Gunnery

Fire Control: 3D

Space Range: 1-5/15/20

Atmosphere Range: 100-500/1.5/2 km

Damage: 4D+1

2 Twin Laser Cannons

Fire Arc: Turret

Crew: 1

Scale: Starfighter

Skill: Starship Gunnery

Fire Control: 3D

Space Range: 1-3/12/25

Atmosphere Range: 100-300/1.2/2.5 km

Damage: 5D

2 Proton Torpedo Launchers

Fire Arc: Front

Crew: 1

Scale: Starfighter

Skill: Projectile Weapons: Proton Torpedoes

Fire Control: 1D

Space Range: 1/3/7

Atmosphere Range: 50-100/300/700

Ammo: 12 torpedoes each

Damage: 9D

Notes: This ship is right on the edge of being capital scale.

Capsule: It was first produced shortly after the end of the Clone Wars. The 52-meter-long vessel was one of the largest to be classified as a "light freighter", and could carry 400 metric tons of cargo. Its design bore some resemblance to the CR90 corvette and Corellian gunship series. The series was popular with smugglers and was favored by high-ranking Imperial Security Bureau agents. Many also found their way into the forces of the Rebellion, and later served in the New Republic.

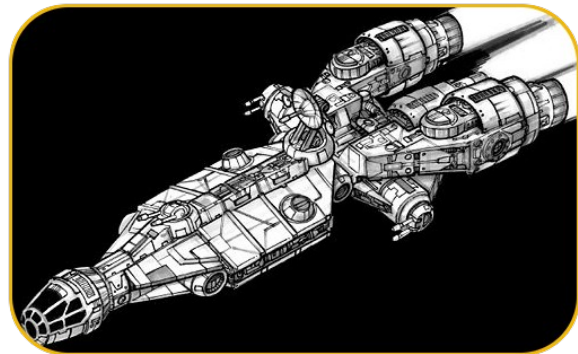

Addendum Personal- General Han Solo

Baay Shfat, we never had anything approaching this when I was running with the Rebellion during the war, if we had the whole thing would have been over a whole lot sooner...and how does this thing even rate being a 'light freighter' anyway?

YZ-785

MEDIUM BULK FREIGHTER

Craft: Corellian Engineering Corporation YZ-785
Transports

Type: Medium Bulk Freighter

Era: Rise of the Empire, Rebellion

Affiliation: General

Source: Arbitrary / Random-Homemade and
appears to originate from RPGGAMER.org

Scale: Capital

Length: 100 meters

Skill: Space Transports: YZ-785

Crew: 8 (1 pilot, 1 co-pilot/gunner, 5 gunners)
skeleton: 1/+5

Passengers: 25

Cargo Capacity: 100,000 metric tons

Consumables: 6 months

Cost: 600,000 (new), 350,000 (used)

Hyperdrive Multiplier: x2

Hyperdrive Back-Up: x15

Nav Computer: Yes

Maneuverability: 1D

Space: 6

Atmosphere: 365; 1,050 kmh

Hull: 6D

Shields: 5D

Sensors:

Passive: 10/3D

Scan: 25/4D

Search: 40/5D

Focus: 2/6D

Weapons:

2 Turbolasers

Fire Arc: Forward

Crew: 3

Scale: Starfighter

Skill: Ship Gunnery

Fire Control: 3D

Space Range: 3-15/35/75

Atmosphere Range: 300-1.5/3.5/7.5 km

Damage: 5D

Capsule: The Corellian Engineering Corporation YZ-785 Transport is something of a mythical beast, much like a jedi or a star dragon, which is to say that few have seen them and fewer still own one. This vehicle rivals Star Destroyers in its ability to carry cargo and withstand tremendous damage as it would take Class I-III class Star Destroyers combined cargo capacity to exceed the amount the YZ-785 can carry. Due to its severe cost overrun during the initial production and poor sales the 785 was phased out and the C.E.C. went back to the drawing boards to create the 900 model.



Addendum Personal- General Han Solo

Baay Shfat, I'm not believing that cargo capacity and why would you need so many gunners on a ship that only has a single placement? I do like the look of the design though; it's like something out of tri-d action serial...

YZ-900

LIGHT FREIGHTER

Craft: Corellian Engineering Corporation YZ-900

Type: Light Freighter

Era: Rise of the Empire, Rebellion

Affiliation: General

Source: Converted- appears to originate from Star Wars Gamer 2

Scale: Starfighter

Length: 54.3 meters

Skill: Space Transports: YZ-900

Crew: 1+2 gunners

Crew Skill: Varies

Passengers: 14

Cargo Capacity: 500 metric tons

Consumables: 9 months

Cost: 300,000 (used)

Hyperdrive Multiplier: x2

Hyperdrive Back-Up: x14

Nav Computer: Yes

Maneuverability: 0

Space: 5

Atmosphere: 330; 950 kmh

Hull: 6D

Shields: 3D

Sensors:

Passive: 20/1D

Scan: 35/1D+1

Search: 80/2D+1

Focus: 2/3D

Weapons:

2 Twin Laser Cannons

Fire Arc: Front

Crew: 1

Scale: Starfighter

Skill: Starship Gunnery

Fire Control: 4D

Space Range: 1-3/12/25

Atmosphere Range: 100-300/1.2/2.5 km

Damage: 4D+1

Capsule: The Corellian Engineering Corporation's YZ-900 was a cargo vessel that appeared to be more of a paramilitary assault craft. Measuring 54.5 meters in length, the YZ-900 was armed with a pair of heavy twin laser cannons, two double laser cannons, and a pair of concussion missile launchers that fired fore and aft. The YZ-900 required a crew of eight to operate, including gunners, and could carry up to fourteen passengers and 500 metric tons of cargo.

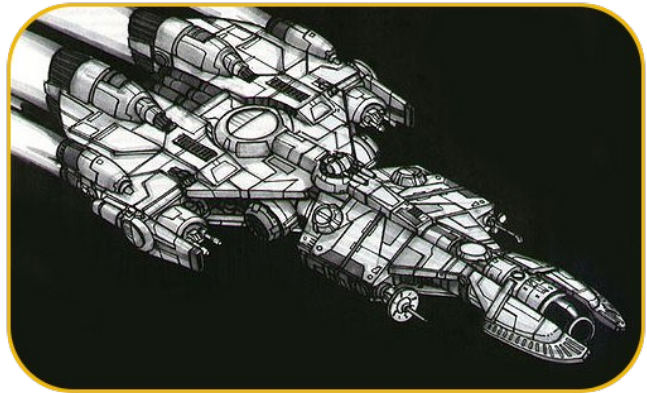

Addendum Personal- General Han Solo

Despite having mentioned all of the weaponry this vessel is supposed to come with standardly, I can't help but notice the official specs only list a single twin laser cannon.

CHAPTER 13

CORVETTES

I wanted to take the time and thank Mr. Solo for letting me write one of these introductions, it seems that he and my dad go back a ways and there is some story about a Sabacc game and an introduction to someone named Bib Fortuna that I'm not entirely privy to, but I digress. Despite the fact that I'm only part Coreellian, and part Alderaanian as my mother likes to point out, the love of flying and being a pilot comes naturally and I'm sure that it is a genetic marker waiting to be discovered in the genes of all Coreellians everywhere.

I grew up surrounded by the opulence of New Alderaan and when I reached my teenage years my father paid for me to take piloting lessons from a twi'lek smuggler friend of his named Hera. I had thrived on the stories he told of fighting in the galactic civil war alongside the likes of Han Solo and Lando Calrissian, those stories fostered something within me just like countless other stories have fostered something within all children throughout the ages. Hera helped me dispel a lot of the myths I had about piloting and Astrogation, she made me realize that as much as I thought I knew, I really knew nothing at all...

As children we all dream of something greater than the sum total of our lives at that moment when our eyes are first opened to the possibility of a dream, usually it's of what might lie beyond the next hill or out beyond the stars we gaze up at in the night sky as the world spins all around us. I wanted to be a pilot and while I eventually became one, it took me running away from home and eking out an existence as a freighter pilot on the big Coreellian ships before I could scratch together enough credits to buy a ship of my own. I spent two long years learning to fly the Corvettes and Bulk freighters; I cut my teeth of a CR-90 named 'Coreellia's Pride'. They're not easy ships to pilot and if anyone tells you that they are, then they're a damn fool for saying it.

Even though they are a class of warship, and despite the official information capsule telling you that they're small, lightly armed and maneuverable, in reality Corvettes are no such thing. With large crew capacities ranging into the hundreds and the ability to move thousands of metric tons of cargo into their holds. These ships are big, bulky and have a backside like a Ronto racing through Mos Shuta looking to run someone over in the streets. But if you truly want to know about Coreellian Corvettes or ships classified as such, and I'm sure that you do since you picked up this book, just

listen to this quote from a good friend of mine.

“My father Stromgald Caballa used to say that if you're looking for a ship that turns on a credit, can thread the needle in Beggars Canyon on Tatooine and out run Imperial Star Destroyers as they try to run you to ground, then you're probably not looking for a Coreellian Corvette. On the other hand, if you want something tough enough take a pounding and still keep going while returning fire on your pursuers, then a Coreellian Corvette might be the ship for you...”

**Kae' Caballa
Jedi**

So if you're looking for something that can move you, your family, their friends and the rest of the people on the street where you live, then these ships are for you and your brood. They can pack the cargo in, protect it during the journey and in some cases the owners of the ship will even help you unpack and set up the house after you get there, the force only knows I had to when I worked for 'Coreellian Shipping Inc.'

**Kyle Pendower
Son of Kazdan Navarro,
*free trader, smuggler and owner of 'The Raven'***

ACTION II

BULK FREIGHTER

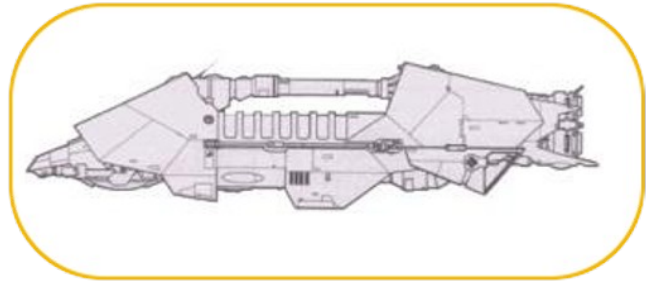

Craft: Corellian Action II Transport
Type: Medium bulk freighter
Era: Old Republic
Affiliation: General
Source: Homemade-Stats contributed by Keith Kilburn
Scale: Capital
Length: 100 meters
Skill: Space transports: Action IV transport
Crew: 12
Crew Skill: Varies widely
Cargo Capacity: 60,000 metric tons
Consumables: 3 months
Cost: 845,000 credits (new), 245,000 credits (used)
Hyperdrive Multiplier: x5
Hyperdrive Backup: No
Nav Computer: No (uses droid or starport computations)
Space: 2
Atmosphere: 225; 650 kmh
Hull: 2D
Sensors:

Passive: 15/0D

Scan: 20/1D

Search: 30/1D

Focus: None

Capsule: The Action II transport was an early Action series bulk transport that looked like a box with an engine and pods for the command and living areas.

Addendum Personal- General Han Solo
See the Action VI for my comments...

ACTION IV

BULK FREIGHTER

Craft: Corellian Action IV Transport

Type: Medium bulk freighter

Era: Old Republic

Affiliation: General

Source: Pirates & Privateers (page 68), The Star Wars Sourcebook (pages 44-45), Starships of the Galaxy (page 77)

Scale: Capital

Length: 100 meters

Skill: Space transports: Action IV transport

Crew: 8

Crew Skill: Varies widely

Cargo Capacity: 75,000 metric tons

Consumables: 3 months

Cost: 945,000 credits (new), 345,000 credits (used)

Hyperdrive Multiplier: x3

Hyperdrive Backup: No

Nav Computer: No (uses droid or starport computations)

Space: 2

Atmosphere: 225; 650 kmh

Hull: 2D

Sensors:

Passive: 15/0D

Scan: 20/1D

Search: 30/1D+2

Focus: None

Capsule: Even though each ship was sold without any weapons or defensive shields built in, plenty of aftermarket systems could be added to the Action IV. It was useful for a variety of services as it had a trapezoidal shape and was roughly 100 meters in length. Internally, its holds could be adapted to various

pressures and climates with individual configurations. During the time of the Galactic Republic, the Action IV transport *Azure Queen* was captured by Black Sun pirates, while en route to the planet Rutan. The Imperial Navy refitted a number of them as Imperial Patrol Ships.

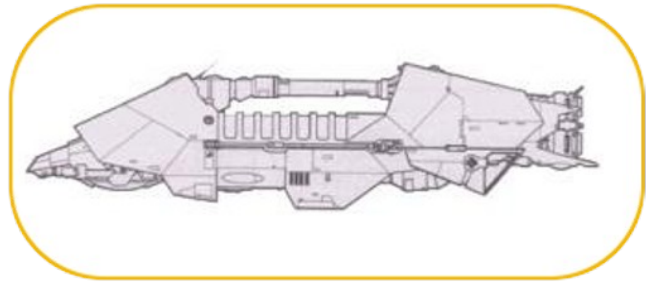

Addendum Personal- General Han Solo

See the Action VI for my comments...

ACTION V

BULK FREIGHTER

in both its predecessor and successor.

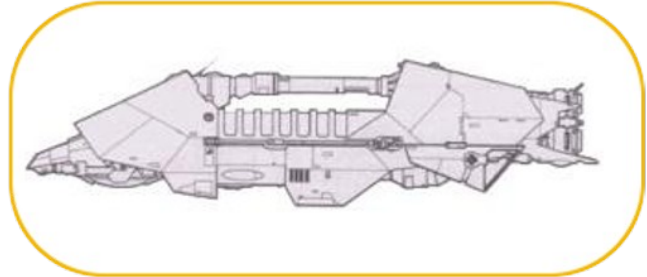

Craft: Corellian Action V Transport
Type: Medium bulk freighter
Era: Rise of the Empire
Affiliation: General
Source: Pirates & Privateers (pages 68-69), Dark Force Rising Sourcebook (pages 131-132), The Thrawn Trilogy Sourcebook (pages 231-232)
Scale: Capital
Length: 115 meters
Skill: Space transports: Action V transport
Crew: 10
Crew Skill: Varies widely
Cargo Capacity: 80,500 metric tons
Consumables: 3 months
Cost: 965,000 credits (new), 435,000 credits (used)
Hyperdrive Multiplier: x4
Hyperdrive Backup: No
Nav Computer: No (uses droid or starport computations)
Space: 2
Atmosphere: 225; 650 kmh
Hull: 2D+2
Shields: 1D
Sensors:
Passive: 20/0D
Scan: 30/1D
Search: 40/1D
Focus: 1/1D

Addendum Personal- General Han Solo

See the Action VI for my comments ...

Capsule: The Action V was a modest upgrade of the older Action IV transport design. Action V freighters couldn't carry as much cargo as the newer Action VI transports, but were also less expensive, and could be found throughout the galaxy in the ownership of private individuals and freelance traders. The Action V was the most popular of the series, despite the fact that its Class 4 Hyperdrive was slower than the Class 3 used

ACTION VI BULK FREIGHTER

Craft: Corellian Action VI Transport
Type: Medium bulk freighter
Era: Rise of the Empire
Affiliation: General, Alliance to Restore the Republic
Source: Rebel Alliance Sourcebook (pages 136-137), Pirates & Privateers (page 69), Heir to the Empire Sourcebook (pages 130-131), The Essential Guide to Vehicles and Vessels (pages 190-191)
Scale: Capital
Length: 125 meters
Skill: Space transports: Action VI transport
Crew: 10, skeleton: 6/+10
Crew Skill: Astrogation 3D, capital ship shields 2D+2, space transports 3D
Cargo Capacity: 90,000 metric tons
Consumables: 3 months
Cost: 1,000,000 credits (new), 500,000 credits (used)
Hyperdrive Multiplier: x3
Hyperdrive Backup: No
Nav Computer: No (uses droid or starport computations)
Space: 2
Atmosphere: 225; 650 kmh
Hull: 3D
Shields: 1D
Sensors:
Passive: 20/0D
Scan: 30/1D
Search: 40/1D+1
Focus: 1/2D

Capsule: Action VI transports typically operated in convoys or in well patrolled areas of space. Since they lacked even the most basic forms of self-defensive measures, such as armor and weaponry, they were often prime targets for pirates and so had to rely on protection from other capital ships and starfighter escorts. The only reason they were used by the Galactic Empire was because they were quite inexpensive relative to Imperial wealth. One of these ships once crashed on Blenjeel, after crossing paths with an Immobilizer 418 cruiser. The Rebel Alliance also employed these cargo vessels, often as personnel carriers, but in much smaller quantities since they were far more expensive than GR-75 medium transports. Most Action VIs were stolen from the Empire. Pirates often modified Action VI ships into "interceptor frigates" capable of combating corvettes. The most famous Action VI was *Wild Karrde*, the personal starship owned by smuggler Talon Karrde.

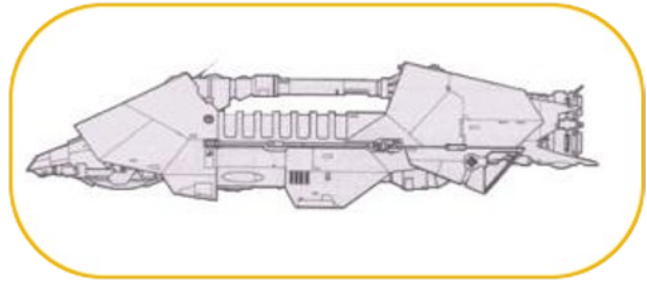

Addendum Personal- General Han Solo

I'll let you in on a little secret that until now was something that the C.E.C. kept under wraps and hotly denied. There was a manufacturing snafu of some sort, I'm told the droid production line generated to many of these chassis' and that's why the entire Action line of ships, at least II-VI, all look just alike. Despite the fact that the CEC list the sizes as 'different' in length, they're not and I know this for a fact because I have an astromech scan to prove it. Besides, you can tell that they're the same ship, just look at the pictures ...

ACTION XII

ARMED BULK FREIGHTER

Craft: Corellian Engineering Corporation's *Action-Keynne XII*-Class
Type: Armed Bulk Transport
Era: New Republic
Affiliation: General
Source: First presented in 'Specter of the Past' by Timothy Zahn, stats by crmcneill
Scale: Capital Ship
Length: 155 meters
Skill: Space Transports: *Action-Keynne XII*
Crew: 95 (20 @ +10) & 37 Gunners
Crew Skill: Astrogation 5D, Gunnery 4D+2, Piloting 5D, Shields 5D, Sensors 4D+2
Passengers: 200 (generally includes 1 full company of security troops, plus VIP suites for passengers)
Cargo Capacity: 60,000 metric tons
Consumables: 1 year
Cost: 12 million new (Not Available For Sale Used at this time)
Hyperdrive Multiplier: x1
Hyperdrive Backup: x10
Nav Computer: Yes
Maneuverability: 1D
Space: 6
Atmosphere: 330; 950 kmh
Hull: 3D+2
Shields: 2D
Sensors:
Passive 40/1D
Scan 80/2D
Search 100/3D
Focus 5/4D

Weapons:

6 Dual Turbolaser Cannons

Fire Arc: Turret
Crew: 3
Scale: Capital
Skill: Capital Ship Gunnery
Fire Control: 3D
Space Range: 3-15/35/75
Atmosphere Range: 300-1.5/3.5/7.5 km
Damage: 5D

8 Dual Heavy Auto-Blasters

Fire Arc: 2 Front/Left, 2 Front/Right, 2 Rear/Left, 2 Rear/Right
Crew: 2
Scale: Capital
Skill: Capital Ship Gunnery
Fire Control: 3D
Space Range: 1-8/25/40
Atmosphere Range: 100-800/2.5/4 km
Fire Rate: 2D Auto-Fire
Damage: 4D

3 Tractor Beam Projectors

Fire Arc: 1 Front/Left, 1 Front/Right, 1 Rear
Crew: 3
Scale: Capital
Skill: Capital Ship Gunnery
Fire Control: 3D
Space Range: 1-5/15/30
Atmosphere Range: 100-500/1.5/3 km
Damage: 5D

Small Craft Complement: Docking bay with room for 4 small shuttles (usually VIP transports)

Capsule: The *Action-Keynne XII* is a departure from normal bulk freighter design. Where most bulk freighters are conceived with an eye for economy and profitability, the *Action-Keynne XII* is intended for those for whom money is no object. Fast, well-armed, capable of transporting large amounts of cargo, and featuring luxurious accommodations for crew and passenger alike, the *Action-Keynne XII* sets the current standard for bulk transports in the galaxy; everything else is second best.

The *Action-Keynne XII* is the result of a design re-

quest by the Sarkans of the planet Sarka. Immensely wealthy due to their planet's rich mineral and gem deposits, they wanted a bulk transport that could quickly deliver its cargo, even at great distances, and defend itself from attack, as well as being a comfortable home away from home. Corellian Engineering Corporation produced the *Action-Keynne XII* to their specifications, but demand for the ship in certain circles led CEC to produce it in a limited run for other customers, mainly wealthy shipping magnates, or the occasional rich customer who has sense to go with his money. The ship has proven to be an excellent design (as should be expected for the price), and no one who has managed to get his or her hands on an *Action-Keynne XII* will let it go easily. As such, at this time, the ships are only available new from CEC.



Addendum Personal- General Han Solo

I got to see the Keynne XII in action when some Thrawn imitator showed up. The New Republic has code phrases and 'action titles' to differentiate one skirmish from another. I guess it's easier than saying 'the other time I ran into Boba Fett...' they refer to this one as Tmit'Zon, I'm told it is a Mon Calamari phrase meaning 'Colossal pain in the a...' (Sounds from off recorder...) What, are you serious? (More sounds from off recorder...) Alright already...So I was just informed that I can't provide a translation for that, something about the CEC being a family oriented company. If you can afford to buy a Keynne XII, then you probably don't need to be gallivanting around the galaxy in a starship. Just buy a planet and set up shop...As a matter of fact I've still got the deed to a planet in the Quelii system with plenty of wildlife and exotic locals ...

BD-27

TRANSPORT

Model: Corellian Engineering Corporation BD-27 Transport

Type: Medium freighter

Era: Old Republic

Affiliation: General

Source: Adventure Journal 9, wookieepedia, with a stats tweak by +Oliver Queen

Scale: Starfighter

Length: 100 meters

Skill: Space transports: BD-27 Transport

Crew: 2 (pilot, co-pilot/navigator)

Cargo Capacity: 30 metric tons (external container 75,000 metric tons)

Consumables: 3 months

Cost: 1.2 million credits (new), 385,000 credits (used)

Hyperdrive Multiplier: x3

Hyperdrive Backup: None

Nav Computer: No (uses droid or starport computations)

Maneuverability: 0D

Space: 2

Atmosphere: 225; 650 kmh

Hull: 2D

Sensors:

Passive: 15/0D

Scan: 20/1D

Search: 30/1D+2

Focus: None

Game Notes: The BD-27 has unique automated systems, but these require constant maintenance to perform optimally. This requires routine maintenance for every 100 hours of operation, moderate starship repair roll and 8 hours. If not maintained the ship drops to -1D. The ship was used to move 75,000 ton cargo containers with little cargo space inside.

Capsule: The BD-27 transport was a Corellian Engineering Corporation barge driver. It was the predecessor to the Action series of medium freighters, and defined the basic shape of that transport. The BD-27 measured 100 meters in length, and its automated systems required only a pilot and co-pilot to operate. However, it required extensive maintenance. The ship had no weapons and weak shields. The entire ship could be connected to a cargo module capable of carrying 75,000 metric tons. The BD-27 was quickly replaced by larger bulk freighters, and was relegated to use in small operations.



Addendum Personal- General Han Solo

If the Action line of ships had an older brother that no one liked to talk about, then it would have been the BD-27. The BD-27 has a long series of problems in my opinion starting with the fact that is slow, has no shields, no maneuverability, no nav-computer, and no backup hyperdrive in the event that the primary goes offline. Despite all of those problems, there is also the near constant need to take it in for maintenance and if you think that the upkeep for a freighter is bad, just try footin' the bill for a BD-27...

C-17 SYSMASTER III LIGHT TRANSPORT

Craft: Corellian Engineering Corporation C-17 Sysmaster III
Type: Light transport
Era: Old Republic, Rise of the Empire, Rebellion
Affiliation: General
Source: +Oliver Queen
Scale: Starfighter
Length: 106 meters
Skill: Space transports: C-17 Sysmaster
Crew: 3 (pilot, co-pilot, loadmaster)
Crew Skill: Varies widely
Passengers: +2 cockpit; 102 troops
Cargo Capacity: 77.5 metric tons
Consumables: 2 months
Cost: 200,000 credits (new), 95,000 credits (used)
Hyperdrive Multiplier: x2
Hyperdrive Backup: x12
Nav Computer: Yes
Maneuverability: 1D
Space: 3
Atmosphere: 260; 750 kmh
Hull: 4D
Shields: 1D
Sensors:
Passive: 10/0D
Scan: 25/1D
Search: 40/2D
Focus: 2/2D+2

Capsule: Developed as a civilian and goods transport, the C-17 was a popular system-to-system transport utilized prior to and during the Clone Wars, during a particularly tight period of the war, the C.E.C. was contracted to manufacture them for military use during the war. In a pinch this work, but the ships were eventually phased out when better designs were introduced and the senate granted more funding for the war effort.



Addendum Personal- General Han Solo

Very large, extremely clunky, and slower than a Hutt at an 'all-you-can-consume-buffet'. While it does have some benefits, the C-17 is known to have issues in that for a military grade ship during the Clone Wars, it had lighter shielding and hull ratings than your typical military grade vessels of the time period. I'm told the reason for that had to do with this line being repurposed from a civilian transport craft adapted into service for the Empire during the later days of the Clone Wars to save on credits when the cost of the war began causing public outcry...

CEC

LIGHT CRUISER

Craft: Corellian Engineering Corporation Light Cruiser

Type: Light cruiser

Era: Old Republic, Rise of the Empire

Affiliation: General

Source: wookieepedia, stats by +Oliver Queen

Scale: Capital

Length: 200 meters

Skill: Capital ship piloting: light cruiser

Crew: 140, gunners: 20, skeleton 18/+10

Passengers: 80 (troops)

Cargo Capacity: 400 metric tons

Consumables: 3 months

Cost: Not available for sale

Hyperdrive Multiplier: x2

Hyperdrive Backup: x15

Nav Computer: Yes

Maneuverability: 1D

Space: 5

Atmosphere: 295; 850kmh

Hull: 4D

Shields: 1D

Sensors:

Passive: 30/0D

Scan: 60/1D

Search: 90/2D

Focus: 3/3D

Weapons:

6 Turbolaser Cannons

Fire Arc: 2 forward, 2 (forward, left), 2 (forward, right)

Crew: 2

Scale: Capital

Skill: Capital gunnery

Fire Control: 3D

Space Range: 3-15/35/75

Atmosphere Range: 300-1.5/3.5/7.5 km

Damage: 4D+1

8 Laser Cannons

Fire Arc: 4 (front, left, rear), 4 (forward, right, rear)

Crew: 1

Scale: Starship

Skill: Starship gunnery

Fire Control: 2D+2

Space Range: 1-3/12/25

Atmosphere Range: 100-300/1.2/2.5 km

Damage: 5D

Capsule: The Corellian Engineering light cruiser was produced by the Corellian Engineering Corporation. They were used by the Republic Outland Regions Security Force in 29 BBY as escort ships for Dreadnaught-class heavy cruisers, and ten were said to be capable of destroying every settlement on Zonama Sekot.

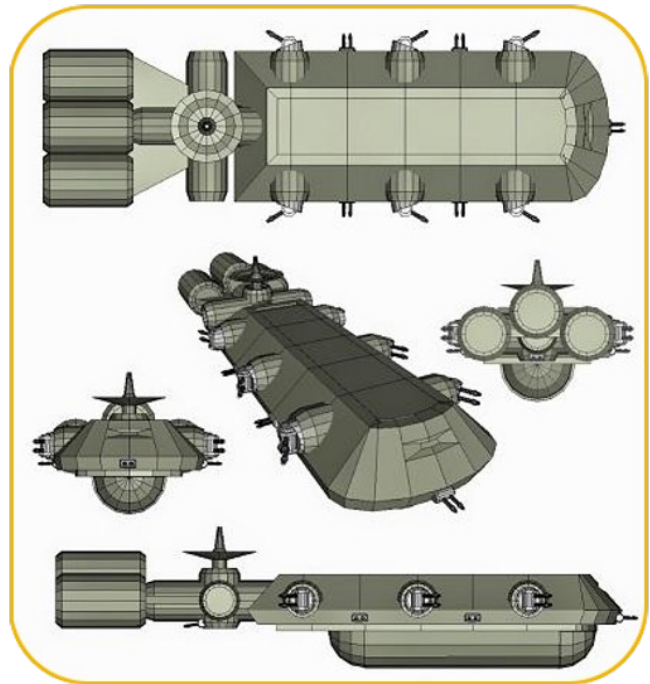

Addendum Personal- General Han Solo

The CEC Light Cruiser was heavily in use during the Clone Wars and was developed specifically for the War. Heavily armed, the Light Cruiser was capable of

CORVETTES

inflicting a lot of damage in a really fast amount of time, the downside of course was that the shield rating for a ship of this size is a little on the 'light' side and then there is the fact that there is no topside gun turret and with the side turrets unable to fire at anything less than forty-five degree inward arc, the ship is vulnerable to attacks along the upper fuselage...

CLASS VI

BULK FREIGHTER

Craft: Corellian Engineering Corporation Class VI Bulk Freighter

Type: Bulk freighter

Era: Old Republic

Affiliation: General

Source: Wookieepedia, stats by +Oliver Queen

Scale: Capital

Length: 180 meters

Skill: Capital ship piloting: class VI

Crew: 4 (pilot, co-pilot/navigator, engineer, loadmaster), gunners: 2; skeleton: 2/+10

Passengers: 2

Cargo Capacity: 2,000 metric tons

Consumables: 6 months

Cost: 4 million credits (new), 1.9 million credits (used)

Hyperdrive Multiplier: x3

Hyperdrive Backup: No

Nav Computer: Yes

Space: 4

Atmosphere: 280; 800 kmh

Maneuverability: 0D

Hull: 3D

Shields: 0D

Sensors:

Passive: 40/1D

Scan: 60/2D

Search: None

Focus: 2/3D

Weapons:

Laser Cannons

Fire Arc: Turret

Crew: 1

Scale: Starfighter

Skill: Starship gunnery

Fire Control: 3D

Space Range: 1-3/12/25

Atmosphere Range: 100-300/1.2/2.5 km

Damage: 4D

Capsule: The Class VI bulk freighter was a type of cargo hauler built by Corellian Engineering Corporation, considered antiquated by the time of the Galactic Civil War. It was developed from the earlier Praetorian-class frigate. The Class VI was 180 meters in length and had a cargo capacity of 2,000 metric tons and a Class 3 Hyperdrive. In standard operation, it could carry a crew of four, with provision for two passengers and supplies for six months, but at a minimum, it could operate with just a pilot and navigator.

Slow and very sluggish at sublight speeds, a standard Class VI lacked a backup hyperdrive, and was armed with a single turret-mounted laser cannon. The Class VI was built on the same hull-form as the *Praetorian*-class frigate, a warship in the Republic fleet which served at least as early as the Battle of Koros Major during the Great Sith War. Thousands of years later, a ship of the same class was launched in around 70 BBY, called the *Hearst*, and was used as the headquarters of the independent newsfeed Freedom Galactic News. The Rebel Alliance Fleet also had at least one such vessel in its forces.



Addendum Personal- General Han Solo

Leave it to the CEC to take a mothballed design like the Praetorian-class frigate and simply slap a different coat paint and name on it to make a few credits. The Class VI gets the job done, that much is true, but getting them going and stopping once you're moving is something of a nightmare. I know a distant cousin of Chewbacca's named Kryzah and some of the members of the Mutt Squad got stuck on one of these things trying to rescue slaves as the ship listed into the atmosphere of a planet. They stopped a slaver operation run by the pirate Jyve Omahlsdahl when a stray satellite smashed into the bridge of the Class VI ...

CONSULAR CLASS

SUPER CRUISER MK-III

Craft: Corellian Engineering Corporation
Consular-class Space Cruiser

Type: Diplomatic transport

Era: Old Republic

Affiliation: Old Republic, General

Source: Starships of the Galaxy (pages 91-92)

Scale: Capital

Length: 115 meters

Skill: Capital ship piloting: Corellian space cruiser

Crew: 8

Crew Skill: Typically 6D in applicable skills

Passengers: 16

Cargo Capacity: 1,000 metric tons

Consumables: 6 months

Cost: 1.25 million credits

Hyperdrive Multiplier: x2

Hyperdrive Backup: No

Nav Computer: Yes

Maneuverability: 0D+2

Space: 6

Atmosphere: 330; 950 kmh

Hull: 4D+2

Shields: 2D

Sensors:

Passive: 40/1D

Scan: 80/2D

Search: 100/3D

Focus: 5/4D

Capsule: The *Consular-class* space cruiser was a starship designed and manufactured by the Corellian Engineering Corporation and used by the Galactic Republic to transport Jedi and diplomats to troubled spots across the Galaxy. Consular cruisers entered service late in the time period of the Republic. They were created due to budget cuts that required the building of

new utilitarian and non-ostentatious starships; it was that quality of them that attracted the Jedi to their use.



Addendum Personal- General Han Solo

Despite the lack of weaponry on the Consular-class cruisers, they are decent enough ships and with the credits that most military or shall we say private investors might have at their disposal this ship could be a force to be reckoned with. Even with the lack of weaponry (and I understand from a diplomatic standpoint why there wouldn't be weapons on the ship), anyone foolish enough to try to board one during their heyday would likely have run into Jedi and from having seen what my brother-in-law is capable of, the unfortunate soul who picked that fight would have soon regretted having done it...

CONSULAR CRUISER CHARGER C-70

Craft: Corellian Engineering Corporation
Consular Cruiser Charger c70 retrofit

Type: Retrofitted diplomatic transport

Era: Old Republic

Affiliation: Galactic Republic

Source: The Clone Wars Campaign Guide
(pg.170)

Scale: Capital

Length: 115 meters

Skill: Capital ship piloting: Consular Cruiser

Crew: 3, gunners: 5, Skeleton: 2/+5

Passengers: 20 (troops)

Cargo Capacity: 6,000 metric tons

Consumables: 6 months

Cost: 1.65 credits million (new),

Hyperdrive Multiplier: x1.5

Hyperdrive Backup: No

Nav Computer: Yes

Maneuverability: +2

Space: 6

Atmosphere: 330; 950 kmh

Hull: 4D+2

Shields: 2D+2

Sensors:

Passive: 40/1D

Scan: 80/2D

Search: 100/3D

Focus: 5/4D

Weapons:

4 Light Turbolasers

Fire Arc: Turret (2 right, 2 left)

Crew: 1

Scale: Capital

Skill: Capital Ship Gunnery

Fire Control: 2D

Space Range: 3-15/35/75

Atmosphere Range: 500-1/3/8 km

Damage: 3D

2 Medium Laser Cannon (Fire-linked)

Fire Arc: Front

Crew: 1

Scale: Starfighter

Skill: Starship gunnery

Fire Control: 2D

Space Range: 1-3/12/25

Atmosphere Range: 100-300/1.2/2.5 km

Damage: 4D

Capsule: The refitting procedure was done early in the Clone Wars, when warships were still in short supply. The former diplomatic ships were converted under direct orders from Supreme Chancellor Palpatine. Jedi General Yoda used such a frigate to reach the moon of Rugosa for a diplomatic meeting with Toydarian King Katuunko. The ship was attacked, but managed to hold off two *Munificent*-class star frigates long enough to fire all escape pods towards the moon, one of which contained the Jedi Master and three clone troopers. Jedi General Aayla Secura attempted to dock one of these ships with the *Resolute* to treat Anakin Skywalker's severe injury, following with the ship's hyperdrive malfunctioning and the ship blasting into hyperspace. After nearly flying into a star, the *Consular*-class ship crash-landed on Maridun.

They were also used to transfer captured Nute Gunray to the *Tranquility*, and when Gunray and Asajj Ventress made their escape. Consular's also evacuated the crew from the *Liberty* during the Sky Battle of Quell. A number of these militarized *Consular*-class cruisers were part of a task force assigned to free captured Jedi Eeth Koth who had been captured by Confederate General Grievous. They were used to transport the Clone Youth Brigade to the *Endurance* as well. One of these ships was used to transport the body of Senator Onaconda Farr back to Rodia after his death. Later in the war, at least three were part of the fleet that battled over Sullust. Another of these vessels was used to transport Anakin Skywalker and Padmé Amidala to the planet Mon Calamari for a failed diplomatic mission. It was destroyed on orders from the Separatist com-

CORVETTES

mander Riff Tamson. Following the Declaration of a New Order, few of the starships survived, with many having been mothballed or broken up. During the Galactic Civil War, the Rebel Alliance deployed several of them. They were known to be well-liked by their crews.



Addendum Personal- General Han Solo

There is very little difference between the C-70 and the Retrofit, other than the addition of weaponry and a new paint job. Shortly after I met my future wife, when the Rebellion was on the run and having to flee from their base on Yavin, they had a half dozen of the retrofits that they had managed to save from some decommission scrapyard, I never did hear exactly how they came by them but as a Corellian standing on the deck of one I can tell you I felt a great swell of pride from the craftsmanship that went into the ship...

CORELLIAN

ASSAULT CORVETTE

Craft: Corellian Engineering Corporation/Wereling Spaceworks' Corvette
Type: Corvette
Era: Rebellion, New Republic
Affiliation: General, Alliance to Restore the Republic
Source: rpggamer.org
Scale: Capital
Length: 175 meters
Skill: Capital ship piloting: Assault Corvette
Crew: 150, gunners: 10, skeleton: 25/+10
Crew Skill: Astrogation 4D+2, capital ship gunnery 4D+1, capital ship piloting 4D, capital ship shields 4D, sensors 4D
Passengers: 100 (troops)
Cargo Capacity: 4,500 metric tons
Consumables: 1.5 years
Cost: 5,000,000 credits (new), 2,500,000 credits (used)
Hyperdrive Multiplier: x2
Hyperdrive Backup: none
Nav Computer: Yes
Maneuverability: 1D
Space: 6
Atmosphere: 330; 950 kmh
Hull: 3D+2
Shields: 4D
Sensors:
Passive: 35/1D
Scan: 70/2D
Search: 100/3D
Focus: 5/4D

Weapons:

3 Quad Turbolaser Batteries

Fire Arc: Turret
Crew: 2
Scale: Capital
Skill: Capital ship gunnery

Fire Control: 1D
Space Range: 3-10/30/60
Atmosphere Range: 6-20/60/120 km
Damage: 7D

2 Ion Cannons

Fire Arc: Turret
Crew: 2
Scale: Capital
Skill: Capital ship gunnery
Fire Control: 3D
Space Range: 1-10/25/50
Atmosphere Range: 2-20/50/100 km
Damage: 4D

Starfighter Complement: 4 starfighters under 18 meters in length

Capsule: The Assault Corvette was a short lived joint project by Corellian Engineering Corporation and Wereling Spaceworks in an attempt to design an effective convoy escort craft. The final designs produced a bulky ship with the infamous 'hammerhead' bridge at the front of the ship which is the main distinguishing feature on the older Corellian Corvettes. A pair of prototypes was produced, one by Corellian Engineering Corporation and another by Wereling Spaceworks. CEC was quick to dismiss the craft as slow, bulky, and cumbersome, not at all living up to their reputation and pulled out of the project seeing it as a waste of money and time. Wereling, however, found the Assault Corvette to be just what they wanted.

Wereling soon built several more of the ships and deployed them to convoy escort duty and soon found that its bulky size and large turbolaser turrets often alone scared off pirate raids. Not long after adequately deploying the ships to protect its vital supply convoys, Wereling began selling the ship on the open market only to find its high price tag often made customers turn to the old, yet reliable, Corellian Corvettes.

CORVETTES



Addendum Personal- General Han Solo

I'm told that these were made in such few numbers that they never even made it into use by the Rebellion who, had that happened, would likely have changed the name to something a little more catchy than 'Assault Cruiser' ... I've never been on one, seen one or know of anyone who has even been near one and I'm people that know people, just ask my wife ...

CORELLIAN BUCCANEER

Craft: Corellian Engineering Corporation
Buccaneer

Type: Corvette

Era: New Republic (~4-6 ABY)

Affiliation: New Republic

Source: wookieepedia, stats by +Oliver Queen

Scale: Capital

Length: 170 meters

Skill: Capital ship piloting: Buccaneer

Crew: 135, gunners: 30; skeleton: 17/+15

Passengers: Up to 600, depending upon configuration

Cargo Capacity: 3,000 metric tons

Consumables: 1 year

Cost: 3.8 million credits (new), 1.7 million credits (used)

Hyperdrive Multiplier: x2

Hyperdrive Backup: No

Nav Computer: Yes

Maneuverability: 2D

Space: 6

Atmosphere: 330; 950 kmh

Hull: 4D

Shields: 2D

Sensors:

Passive: 40/1D

Scan: 80/2D

Search: 100/3D

Focus: 5/4D

Weapons:

10 Double Turbolaser Cannons

Fire Arc: 4 front, 2 left, 2 right, 2 back

Crew: 3

Scale: Capital

Skill: Capital ship gunnery

Fire Control: 3D

Space Range: 3-15/35/75

Atmosphere Range: 6-30/70/150 km

Damage: 5D

Capsule: This limited run series of corvettes were crafted for use by the New Republic in the time before the return of Grand Admiral Thrawn. They were given to privateers who used the ships to plunder the resources of the Empire. The *Buccaneer*-class was decommissioned shortly before Grand Admiral Thrawn returned from wild space.

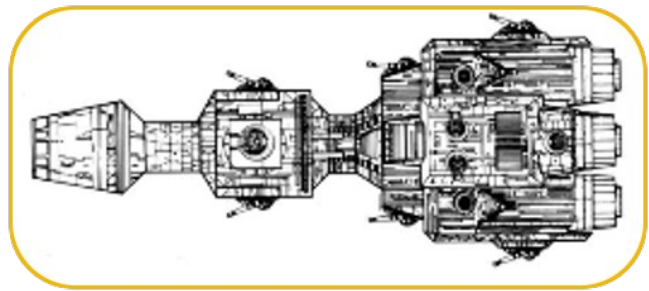

Addendum Personal- General Han Solo

It's too bad that Mon Mothma and Admiral Ackbar pushed for the decommission of these ships in the months before the Thrawn attacks. The Admiral has never had any great love for smugglers or pirates and managed to push the decommission through the council. I've often wondered if he regretted that in light of what happened later...

CORELLIAN

SYSTEM PATROL CRAFT

Craft: Corellian Engineering Corporation's Patrol Craft

Type: System patrol craft

Era: Old Republic

Affiliation: Galactic Republic

Source: Ryan Matheny (rpggamer.org)

Scale: Capital

Length: 132 meters

Skill: Capital ship piloting: Corellian patrol craft

Crew: 3, gunners: 8, skeleton: 2/+15

Crew Skill: Capital ship gunnery 4D, capital ship piloting 5D, capital ship shields 4D, sensors 3D, starship gunnery 4D

Passengers: 16 (troops)

Cargo Capacity: 250 metric tons

Consumables: 2 months

Cost: Not available for sale

Maneuverability: 2D

Space: 8

Atmosphere: 350; 1,000 kmh

Hull: 3D

Shields: 3D

Sensors:

Passive: 50/1D

Scan: 100/2D

Search: 150/3D

Focus: 5/3D+2

Weapons:

3 Turbolaser Cannons

Fire Arc: 1 front, 1 left, 1 right

Crew: 2

Scale: Capital

Skill: Capital ship gunnery

Fire Control: 2D

Space Range: 3-15/35/75

Atmosphere Range: 300-1.5/3.5/7.5 km

Damage: 3D+2

2 Quad Laser Cannons

Fire Arc: 1 dorsal turret, 1 ventral turret

Crew: 1

Scale: Starfighter

Skill: Starship gunnery

Fire Control: 3D+2

Space Range: 1-3/12/25

Atmosphere Range: 100-300/1.2/2.5 km

Damage: 4D

Capsule: Much like the famed Corellian corvette and Corellian space cruiser, the Corellian Patrol Craft was a highly reliable starship which could easily continue to serve its intended role for many decades with the proper maintenance and still be on the cutting edge of modern warships. Used according to its designated role, this system patrol craft would be used to apprehend smuggling vessels, regulate space lanes and serve as a planet's first line of defense during an attack.

It was built to engage in "pre-jump" combat, making maximum use of speed and maneuverability to catch fleeing vessels before they can escape into hyperspace. Like many other system patrol craft, the Corellian version was not equipped with hyperdrive engines; instead it was forced to rely on its powerful sublight engines to make its way through a star system. The crew of this vessel would spend long periods off-world, patrolling the borders of their star system. The ships would be called upon to respond quickly to any ships leaving the system with stolen or smuggled goods, making the crews remain on constant watch for threats. The Corellian patrol craft could spend up to two full months on patrol in a star system, ready to react to any threat from within the system or from beyond.

CORVETTES

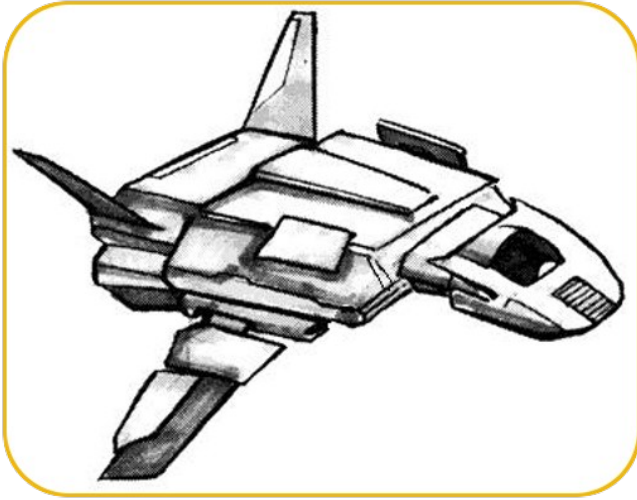

Addendum Personal- General Han Solo

Let me tell you from the experience of having run from the Patrol Craft in the past, they give as good as they get. These highly crafted and well thought-out law-enforcement vessels can run down most freighters and even give some starfighters a run for their credits. If you find yourself on the end of a comms call asking you to kill the engines and prepare to be boarded you might want to at least consider it before running ...

CORVETTES

CR80

CORVETTE

Craft: Corellian Engineering Corporation CR80 Corvette

Type: Mid-sized multipurpose vessel

Era: Old Republic

Affiliation: Old Republic, General

Source: wookieepedia, stats by +Oliver Queen

Scale: Capital

Length: 185 meters

Skill: Capital ship piloting: Corellian corvette

Crew: 100, gunners: 24; skeleton: 12/+10

Passengers: 50 (up to 500 depending on configuration)

Cargo Capacity: 5,000 metric tons (up to 10,000 metric tons depending on configuration)

Consumables: 1 year

Cost: 3.1 million (new), 1.2 million (used)

Hyperdrive Multiplier: x2

Hyperdrive Backup: None

Nav Computer: Yes

Maneuverability: 1D+2

Space: 6

Atmosphere: 330; 950 kmh

Hull: 4D

Shields: 2D

Sensors:

Passive: 35/1D

Scan: 70/2D

Search: 90/3D

Focus: 4/4D

Weapons:

8 Double Turbolaser Cannons

Fire Arc: 4 Turret (front, left, right), 2 turret (front, left, rear), 2 (front, right, rear)

Crew: 3

Scale: Capital

Skill: Capital ship gunnery

Fire Control: 3D

Space Range: 3-15/35/75

Atmosphere Range: 6-30/70/150 km

Damage: 4D+2

Vehicle Complement: 1 or 2 shuttles

Capsule: The CR80 is a warship, similar in appearance to the CR70 and CR90 corvettes. It is much larger than other CR-series corvettes, with 24 engines arranged in rows of 3. It has two magnetic hangar bay entrances on the port and starboard sides that share a common hangar bay. the CR80 could take on board several fighters and smaller transport vessels. Its bridge was substantially larger than the ones on the smaller CEC classes, having enough room for several crew members to walk around in.

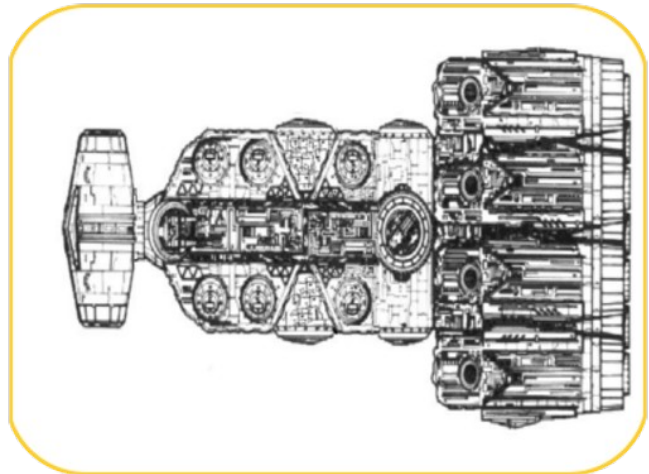

Addendum Personal- General Han Solo

I'm told that the Jedi made some use of the old CR-80s before they were mothballed after the Clone Wars. I've never seen one in action, but I'm told that they're like a giant-sized Corellian Corvette, based on the holopic above it looks like something someone made up for those computer simulations my kids are always playing...

CR90

CORVETTE

Model: Corellian Engineering Corporation CR-90 Corvette

Type: Multipurpose mid-sized vessel

Era: Rise of the Empire, Rebellion, New Republic

Affiliation: General

Source: Too numerous to list...

Scale: Capital

Length: 154 meters

Skill: Capital Ship piloting: Corellian corvette

Crew: 30 to 165, depending upon configuration

Crew Skill: Varies widely

Cargo Capacity: 3,000 metric tons

Consumables: 1 year

Cost: 3.2 million credits (new), 1.3 million credits (used)

Hyperdrive Multiplier: x2

Hyperdrive Backup: No

Nav Computer: Yes

Maneuverability: 2D

Space: 6

Atmosphere: 330; 950 kmh

Hull: 4D

Shields: 1D+2

Sensors:

Passive: 40/1D

Scan: 80/2D

Search: 100/3D

Focus: 5/4D

Weapons:

2 Double Turbolaser Cannons

Fire Arc: 1 dorsal turret, 1 ventral turret

Crew: 1

Scale: Capital

Skill: Capital ship gunnery

Fire Control: 3D

Space Range: 3-15/35/75

Atmosphere Range: 6-30/70/150 km

Damage: 4D+2

Capsule: The Corellian Corvette was a common multipurpose vessel. It was a modular design and could be configured for cargo transport, passenger liner service, or even military duty. The Corellian Corvette was so common among legitimate shipping, passenger, and government interests that many pirates and smugglers had taken to using it for their own purposes. The CR-90 was the most commonly found corvette in service. It was the least costly of the entire series, being sold in bulk to the Empire, planetary defense militias, legitimate businesses and even the Rebel Alliance. It had only two double turbolaser cannons, sacrificing the additional weaponry that most of the other models boasted. Slightly less powerful shield generators also made the CR-90 a bit more affordable. While the Alliance used the CR-90 as a combat warship, the Empire usually kept their CR-90s in service as convoy vessels and patrol ships.



Addendum Personal- General Han Solo

When you talk to civilians and ask them to name two Corellian ships of any make and model, they will without failure name either the Corellian Corvette or the YT-1300. I think that the CEC has made more credits off of those two ships than anything else in their catalog of ships. The CR-70 and '90 are workhorse ships, they are tough, ready for a fight and keep going even after they've been beaten 'til you think that they

CORVETTES

just can't take anymore. My wife owned one that she inherited from her adopted father; she ended up using it to help steal the Death Star plans after he supposedly used it to smuggle Jedi younglings to safety..

CR90T

"TUG-VETTE"

Craft: Corellian Engineering Corporation's CR90T-Class

Type: Interstellar Towing Ship

Era: Rebellion, New Republic

Affiliation: General

Source: crmcneill

Scale: Capital

Length: 150 meters

Skill: Capital Ship Piloting: CR-90T

Crew: 65 (35 @ +10) & 16 Gunners

Crew Skill: Astrogation 3D, Capital Ship Gunnery 4D+2, Capital Ship Piloting 3D+2, Capital Ship Shields 3D+1, Capital Ship Sensors 3D+2

Passengers: 10

Cargo Capacity: 200 metric tons

Consumables: 1 year

Cost: 4.1 million credits (new), 1.9 million credits (used)

Hyperdrive Multiplier: x2

Hyperdrive Backup: x8

Nav Computer: Yes

Maneuverability: 2D

Space: 6

Atmosphere: 330; 950 kmh

Hull: 5D

Shields: 1D

Sensors:

Passive 40/1D

Scan 80/2D

Search 100/3D

Focus 5/4D

Weapons:

2 Tractor Beam Projectors

Fire Arc: Turret (1 top, 1 bottom)

Crew: 4

Scale: Capital

Skill: Capital Ship Gunnery

Fire Control: 3D

Space Range: 1-5/10/30

Atmosphere Range: 100-500/1/3 km

Strength: 5D

4 Turboblasters Cannon

Fire Arc: 2 Front/Left, 2 Front/Right

Crew: 2

Scale: Capital

Skill: Capital Ship Gunnery

Fire Control: 3D*

Space Range: 1-10/20/50

Atmosphere Range: 100-1/2/5 km

Damage: 4D*

Note: Turboblasters have an alternate rapid-fire mode that fires a stream of smaller blasts instead of one large one. In game terms, rapid-fire mode transfers 3D from Damage to Fire Control, in effect turning the cannon into a 0D/7D starfighter-scale cannon. Transitioning between modes requires one full round, during which the cannon cannot be fired.

Small Craft Complement: 1 pinnacle; 2 workpods

Special Rules:

Towing Capacity: The Tug-Vette can tow any ship up to 4D Hull with no reduction in performance. However, for every pip above 4D, the ship's performance begins to suffer (-1 Space, -1 Maneuverability, and +1 to Hyperdrive Modifier per pip). Multiple Tug-Vettes may coordinate to tow a single ship, increasing the performance threshold by 1D per tug, but normal coordination rules apply.

Capsule: The Corellian CR90 Corvette has spawned many variants. One of the more common is the interstellar towing variant, used to transport damaged ships or non-hyperspace capable platforms (such as space stations and skyhooks) through hyperspace. While known officially as the CR90T, it is more popularly known by the colloquialism "Tug-Vette". The Tug-Vette replaces the standard CR90's turret mounted dual turbolasers with a pair of heavy tractor beam projectors, supplemented by a pair of short ranged towing tractors on either side of the ship's engines. The arma-

CORVETTES

ment is rounded out by a quartet of turboblasters: heavy dual-purpose energy cannon that can be used against starfighters or capital ships. In addition, the ship has been equipped with more powerful reactors and power distribution systems, and the hull has been reinforced by and augmented by magnetic structural integrity fields. Also, the bow cargo hold has been replaced by a massive pressor field generator. A pressor field is, essentially, the opposite of a tractor beam, as it pushes objects away from the ship instead of pulling it toward it. The bow mounted pressor field allows the Tug-Vette to push against a vessel without physically coming into contact with it, and the field is sufficiently powerful that the Tug-Vette's drives cannot overcome it (i.e. the tug can't push through the field, so all the kinetic energy is transferred to the target). When towing a ship through hyperspace, the Tug-Vette places Hyperdrive field booster relays on the hull of the towed vessel in order to strengthen and expand its Hyperdrive field.

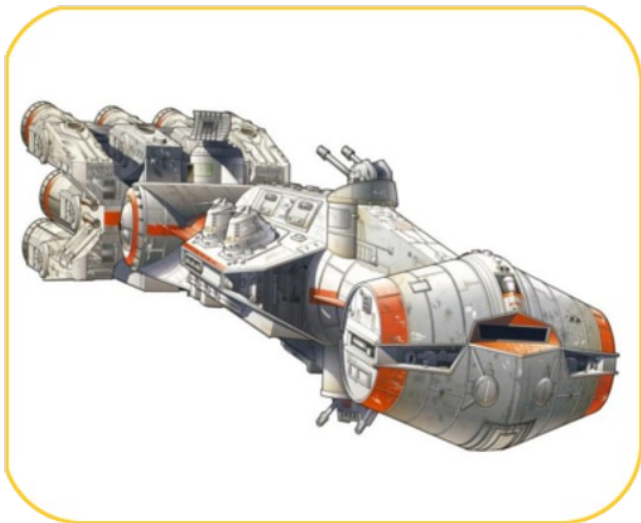

Addendum Personal- General Han Solo

You don't see many of the 90-T, it was a ship that never really took off and while the CEC has put them to good use locally, you're not likely to see them elsewhere...

CR-92

CORVETTE

Model: Corellian Engineering Corporation CR-92 Corvette

Type: Multipurpose mid-sized vessel

Era: Rise of the Empire, Rebellion, New Republic

Affiliation: General

Source: Ryan Matheny (rpggamer.org)

Scale: Capital

Length: 154 meters

Skill: Capital Ship piloting: Corellian corvette

Crew: 30 to 165, depending upon configuration

Crew Skill: Astrogation 3D, capital ship piloting 3D+2, Capital ship gunnery 4D+1, capital ship shields 3D, sensors 3D+1

Cargo Capacity: 3,000 metric tons

Consumables: 1 year

Cost: 3.5 million credits (new), 1.5 million credits (used)

Hyperdrive Multiplier: x2

Hyperdrive Backup: No

Nav Computer: Yes

Maneuverability: 2D

Space: 6

Atmosphere: 330; 950 kmh

Hull: 4D

Shields: 2D

Sensors:

Passive: 40/1D

Scan: 80/2D

Search: 100/3D

Focus: 5/4D

Weapons:

2 Double Turbolaser Cannons

Fire Arc: 1 dorsal turret, 1 ventral turret

Crew: 1

Scale: Capital

Skill: Capital ship gunnery

Fire Control: 3D

Space Range 3-15/35/75

Atmosphere Range: 6-30/70/150 km

Damage: 4D+2

4 Turbolaser Cannons

Fire Arc: 2 left dorsal turret, 2 right dorsal turret

Crew: 1

Scale: Capital

Skill: Capital ship gunnery

Fire Control: 3D

Space Range 3-15/35/75

Atmosphere Range: 6-30/70/150 km

Damage: 4D

Capsule: The Corellian Corvette was a common multipurpose vessel. It was a modular design and could be configured for cargo transport, passenger liner service, or even military duty. The Corellian Corvette was so common among legitimate shipping, passenger, and government interests that many pirates and smugglers had taken to using it for their own purposes. The CR-92 is what Corellian Engineering Corporation advertised as THE Corellian Corvette. Adequately armed and armored, the CR-92 was a very versatile vessel.



Addendum Personal- General Han Solo

'The' Corellian Corvette is simply an overstocked CR-90 with a couple turbolasers and slight better shields. I call this 'padding' the catalog...

CR-92A

ASSASSIN-CLASS

CORVETTE

Model: Corellian Engineering Corporation CR-92A *Assassin*-class Corvette

Type: Corvette

Era: Rise of the Empire, Rebellion, New Republic

Affiliation: Alliance to Restore the Republic, New Republic

Source: Suns of Fortune (p.113), stats by +Oliver Queen

Scale: Capital

Length: 139.5 meters

Skill: Capital Ship piloting: Corellian corvette

Crew: 60-150 depending on configuration, gunners: 6, skeleton: 12/+15

Passengers: 50

Cargo Capacity: 2,100 metric tons depending on configuration

Consumables: 1 year

Cost: 2.5 million credits (used)

Hyperdrive Multiplier: x2

Hyperdrive Backup: 16

Nav Computer: Yes

Maneuverability: 1D+2

Space: 6

Atmosphere: 330; 950 kmh

Hull: 4D+1

Shields: 2D+2

Sensors:

Passive: 40/1D

Scan: 80/2D

Search: 100/3D

Focus: 5/4D

Weapons:

6 Dual Medium Turbolaser Batteries

Fire Arc: Turret (3 front, left, rear), (3 front, right, rear)

Crew: 3

Scale: Capital

Skill: Capital ship gunnery

Fire Control: 3D

Space Range: 3-15/35/75

Atmosphere Range: 6-30/70/150 km

Damage: 4D+2

2 Quad Laser Cannon Turrets

Fire Arc: Turret

Crew: 1

Scale: Starship

Skill: Starship gunnery

Fire Control: 3D+2

Space Range: 1-3/12/25

Atmosphere Range: 100-300/1.2/2.5 km

Damage: 5D+2

Proton Torpedo Launcher

Fire Arc: Front

Crew: 3

Scale: Capital

Skill: Capital ship gunnery

Fire Control: 3D+2

Space Range: 2-12/30/60

Atmosphere Range: 4-24/60/120 km

Ammo: 10 torpedoes

Damage: 6D+1

Medium Tractor Beam Projector

Fire Arc: Front

Crew: 2

Scale: Capital

Skill: Capital ship gunnery

Fire Control: 4D

Space Range: 1-5/15/30

Atmosphere Range: 2-10/30/60 km

Damage: 4D

Capsule: Based on the highly successful CR90 corvette, the CR92a *Assassin*-class corvette is a more heavily armed and armored variant designed with naval and long-range patrol duties in mind. A sleek, purpose-built capital ship, the *Assassin*-class has been readily adopted by the Imperial Navy and Corellian defense fleet. These vessels fulfill several roles, serving as pickets and starfighter screens for larger ships, escorting convoys, or patrolling space lanes. Like most CEC-

CORVETTES

built vessels, the CR92a is fast and agile for a ship of its size, allowing it to rapidly react to threats or chase down pirates.

The corvettes boast six Taim & Bak dual turbolasers, two quad laser cannons for point defense, and a proton torpedo launcher. While the heavy armament of the CR92a allows it to outgun most ships of comparable size and even be a threat to frigates and light cruisers, starfighters can still pose a problem for these vessels. To contend with this shortcoming, Corellian doctrine typically pairs a CR92a with a DP20 gunship for long-range patrols. Such a patrol can readily deal with any threat it is likely to encounter.



Addendum Personal- General Han Solo

Back when we were fighting the war I got to see the collective firepower that the CR-92 could unleash and when Admiral Ackbar uses a phrase like 'We'll rain hell down on them', well he isn't kidding around. The fleet got caught on the fringe of the Dantooine System and we happened to have a CR-92 with us, the Raishi. A Star Destroyer based in the Dantooine system gave chase and the commander of the CR-92 was able to hold off the Raishi while the fleet made the jump to light speed. We lost the ship, but saved the fleet. The Raishi crash landed on Parakus and I am told that all hands were lost...

CR95

ASSASSIN CORVETTE

Model: Corellian Engineering Corporation CR-95 Corvette

Type: Corvette

Era: Rise of the Empire, Rebellion

Affiliation: Galactic Empire

Source: Ryan Matheny (rpggamer.org)

Scale: Capital

Length: 156 meters

Skill: Capital Ship piloting: Corellian corvette

Crew: 56, gunners: 6, skeleton: 12/+15

Crew Skill: Astrogation 3D, capital ship piloting 3D+2, capital ship gunnery 4D+1, capital ship shields 3D, sensors 3D+1, starship gunnery 4D+1

Cargo Capacity: 500 metric tons

Consumables: 1 year

Cost: 4 million (new), 1.8 million (used)

Hyperdrive Multiplier: x2

Hyperdrive Backup: No

Nav Computer: Yes

Maneuverability: 1D+2

Space: 6

Atmosphere: 330; 950 kmh

Hull: 4D+1

Shields: 2D+2

Sensors:

Passive: 40/1D

Scan: 80/2D

Search: 100/3D

Focus: 5/4D

Weapons:

2 Double Turbolaser Cannons

Fire Arc: 1 dorsal turret, 1 ventral turret

Crew: 1

Scale: Capital

Skill: Capital ship gunnery

Fire Control: 3D

Space Range: 3-15/35/75

Atmosphere Range: 6-30/70/150 km

Damage: 4D+2

4 Laser Cannons

Fire Arc: 2 left dorsal turret, 2 right dorsal turret

Crew: 1

Scale: Starfighter

Skill: Starship gunnery

Fire Control: 3D+2

Space Range: 1-3/12/25

Atmosphere Range: 100-300/1.2/2.5 km

Damage: 3D+2

Starfighter Complement:

4 TIE fighters (or fighters of equivalent size) or 1 light transport (no more than 30 meters long and 10 meters tall)

Capsule: The Corellian Corvette was a common multipurpose vessel. It was a modular design and could be configured for cargo transport, passenger liner service, or even military duty. The Corellian Corvette was so common among legitimate shipping, passenger, and government interests that many pirates and smugglers had taken to using it for their own purposes. The Empire, vastly dependent on its numerous short-ranged TIE starfighters, often found itself inventing new ways of transporting TIEs in situations that were not important enough to warrant the deployment of a carrier or escort frigate. Convoys often times fell under Rebel and pirate attack, sometimes with little to no protection, simply due to the fact that the Imperial Navy did not wish to divert any capital ships for escort duty. Those convoys lucky enough to have at least minimal Imperial protection had much higher survival rates. Why was this? Imperial TIE fighters. TIEs outmatched many of the ragtag starfighters which were commonly used by many pirate and Rebel outfits. If the TIEs could hold off attacking starfighters and serve as a nice distraction against any larger vessels, the convoy could usually escape into hyperspace.

After the Imperial Navy began deploying the Corellian corvette and Corellian gunship as convoy escorts it soon began experimentally outfitting a handful of corvettes with starfighter racks to carry TIEs. Corporate bigwigs at CEC, being aware of the Empire's need for a

CORVETTES

light starfighter carrying starship, offered up a more combat-oriented version of its famed corvette, the Assassin. The Assassin resembled the original corvette but with a more streamlined hull. The dorsal and ventral double turbolaser turrets remained, as they had proven to be highly effective in combat. However, the four turbolaser cannons were replaced by four laser cannons for anti-starfighter work to support its own carried starfighters. In addition, increased hull armor and a more efficient shield generator made the Assassin and overall better combat starship. What really made the Assassin worthy of the Imperial Navy was its ability to carry a flight of four TIE starfighters. The small hangar bay only required slight modification to enable the Assassin to carry larger starfighters like the assault gunboat. The bay could also be fitted to carry an assortment of light transports or shuttles should the mission call for it. Assassins were most commonly seen being deployed as convoy escorts, although some commanders used them in combat lines. They were typically deployed in groups ranging from two to four.



Addendum Personal- General Han Solo

I'd heard that the Imperials had used the CR-Assassin class vessels in some cases, but I hadn't seen it. I guess I just naturally assumed that they were using the CR-92, I've never even seen these '95s before. It looks like a re-purposed CR-90 with some heavy modifications. It makes me wonder why the Rebellion or the Republic never put any of these to use...

CR100

CORVETTE

Craft: Corellian Engineering Corporation CR100 Corvette

Type: Midsized multipurpose vessel

Era: New Republic (sometime after 4 ABY)

Affiliation: General, Alliance to Restore the Republic, Galactic Empire, Imperial Remnant

Source: Phantom VX2000, stats by +Oliver Queen

Scale: Capital

Length: 200 meters

Skill: Capital ship piloting: Corellian Corvette

Crew: 35-140, depending on configuration

Crew Skill: Astrogation 3D, capital ship gunnery 4D+1, capital ship piloting 3D+2, capital ship shields 3D, sensors 3D+1

Passengers: Up to 700, depending on configuration

Cargo Capacity: Up to 4000 tons, depending on configuration

Consumables: 1 year

Cost: 3.5 million (new), 1.5 million (used)

Hyperdrive Multiplier: x1

Hyperdrive Backup: x8

Nav Computer: Yes

Maneuverability: 2D

Space: 7

Atmosphere: 350; 1,000 kmh

Hull: 4D+2

Shields: 2D

Sensors:

Passive: 40/1D

Scan: 80/2D

Search: 100/3D

Focus: 5/4D

Weapons:

2 Double Turbolaser Cannons

Fire Arc: Turret (front, right, left, back)

Crew: 1

Scale: Capital

Skill: Capital ship gunnery

Fire Control: 3D

Space Range: 3-15/35/75

Atmosphere Range: 6-30/370/150 km

Damage: 5D+1

8 Double Rapid-Fire Light Turbolaser Turrets

Fire Arc: 4 right, 4 left

Crew: 1

Skill: Capital ship gunnery

Scale: Capital

Fire Control: 3D

Space Range: 3-15/35/70

Atmosphere Range: 6-30/70/150 km

Damage: 5D

2 Proton torpedo launchers

Fire Arc: 1 front, 1 back

Crew: 1

Scale: Capital

Skill: Capital ship gunnery

Fire Control: 3D+2

Space Range: 2-12/30/60

Atmosphere Range: 4-24/60/120 km

Ammo: 50 torpedoes each

Damage: 7D

2 Tractor Beam Projectors

Fire Arc: 1 front, 1 back

Crew: 1

Scale: Capital

Skill: Capital ship gunnery

Fire Control: 2D

Space Range: 1-5/15/30

Atmosphere Range: 2-10/30/60 km

Damage: 5D

Capsule: A highly versatile warship, the CR100 was designed as a high-performance, modular successor to the famed CR90 corvette. Like its predecessor, the interior of the CR100 featured a modular design to allow for ease of reconfiguration of the corvette from one function to another. The weapon systems varied, although the standard configuration mounted two dual

CORVETTES

turbolaser cannons, eight rapid-fire light turbolaser cannons, two proton torpedo launchers, and two tractor/pressor beam projectors. However, the combat-oriented corvette could carry as many as eight turbolasers, twelve rapid-fire light turbolasers, and four proton torpedo launchers. The passive protection found on the CR100 was much better than the CR corvette due to its high-grade durasteel alloy, which allowed the CR100 to withstand severe punishment in combat.

Due to its high performance nature, the CR100 was capable of sustaining acceleration up to 3500G, allowing it to catch up with faster smuggling vessels or hostile warships. The CR100 was also equipped with a class 0.75 Hyper-drive for rapid movement and response. Able to accelerate to a sustained cruising speed of point-seven five past lightspeed, this allowed the CR100 to rush in mere minutes from home base to border. This feature enabled the CR100 to respond more effectively to piracy or raiding activity. But because of its impressive capabilities, the CR100 was somewhat more expensive than its predecessor.

use. In the aftermath of the war the pirate 'admiral' Jyve Omahlsdahl managed to get one as a part of his 'fleet' and put it to 'good' use...



Addendum Personal- General Han Solo

Powerful, sleek and armed to the teeth. The Corellian Engineering Corporation went out of their way to create a gunship without calling it a gunship and every despot, warlord and would be pirate-king wanted one. So did the New Republic and the Imperial forces, but those who were willing and able to step outside of the law to get their hands on them put them to very good

CRUSADER

XX-777

PROTOTYPE DROID FRIGATE

Craft: Nerfworks Crusader XX-777 Prototype Droid Frigate

Type: Prototype military droid starship

Era: Rise of the Empire

Affiliation: General

Source: Gamer Magazine Issue 10

Scale: Capital

Length: 120 meters

Skill: Capital Ship Piloting: XX-777

Crew: Droid brain

Crew Skill: Astrogation 7D, Sensors 7D, Capital Ship Piloting 7D, Capital Ship Gunnery 7D, Capital Ship Shields 7D

Passengers: 30

Cargo Capacity: 300 metric tons

Consumables: 2 years

Cost: Not available for sale (1.8 million credits estimated value)

Hyperdrive Multiplier: x1.5

Hyperdrive Backup: x10

Nav Computer: Yes

Space: 4

Atmosphere: 168; 480 kmh

Hull: 4D+2

Shields: 2D+1

Sensors:

Passive: 40/1D

Scan: 80/2D

Search: 100/3D

Focus: 5/4D

Weapons:

2 Turbolasers (fire separately)

Fire Arc: Partial Turret (1 front, left, rear; 1 front, right, rear)

Crew: 1

Scale: Capital

Skill: Capital ship gunnery

Fire Control: 3D

Space Range: 3-15/35/75

Atmosphere Range: 6-30/70/150 km

Damage: 7D

2 Heavy Ion Cannons (fire separately)

Fire Arc: Front

Crew: 1

Scale: Capital

Skill: Capital ship gunnery

Fire Control: 2D

Space Range: 1-3/7/36

Atmosphere Range: 100-300/700/3.6 km

Damage: 8D

2 Assault Concussion Missile Tubes

Fire Arc: 1 front, 1 rear

Crew: 1

Scale: Starfighter

Skill: Starship gunnery

Fire Control: 1D

Space Range: 2-12/30/60

Atmosphere Range: 4-24/60/120 km

Ammo: 30 missiles each

Damage: 9D

Capsule: One of the most novel features of the XX-777 was the use of a brain from a military protocol droid several centuries old. It would therefore have accumulated vast amounts of military experience and data. The intent was to bypass the time-consuming process of compiling and testing a heuristic processor from the ground up. In this capacity it excelled, swiftly learning the skills to operate as a starship. Opting to avoid memory wipes that would contradict the point of using the experienced brain, the Nerfworks designers implemented a set of baseline protocols that were hard-wired into the Crusader's processor.

They were:

1. Protect the innocent
2. Obey any order that does not violate the previous protocol
3. Preserve its own safety as long as that did not violate the first two protocols.

CORVETTES

This combination of hardware and programming ingenuity resulted in a product that greatly surpassed expectations. The droid ship expertly succeeded in all tests, and the design crew were eager to disassemble the prototype to begin study and replication of its systems for the mass market. It is speculated that this was perceived by the Crusader as a threat to its third directive. Other theories point to deliberate reprogramming by an internal saboteur. Whatever the cause, the ship vanished into hyperspace, and the lab officially labeled it as destroyed and sealed all project records.

Reports occasionally surfaced describing rescues of stranded spacers and piracy victims out on the fringe. These reports described a large, unmanned vessel matching the Crusader's specifications. Without a means of attempting its own maintenance, it was supposed that sentient associates aided in any repairs and resupply that the XX-777 required.



Addendum Personal- General Han Solo

I'm not too keen on the idea of armed droid ships, I'm not overly fond of droids to begin with, but when you start arming them and letting them move around without any oversight it becomes a dangerous thing. IG-88, 31-X, HK-47 and C-3PX. The list goes on and on...

DP-20

FRIGATE

Craft: Corellian Engineering Corporation DP-20 frigate

Type: Mid-sized anti-starfighter warship

Era: Rise of the Empire, Rebellion

Affiliation: General

Source: Too numerous to list.

Scale: Capital

Length: 120 meters

Skill: Capital ship piloting: Corellian gunship

Crew: 45, gunners: 46, skeleton: 10/+15

Crew Skill: Astrogation 3D+1, capital ship gunnery 4D+2, capital ship piloting 4D, capital ship shields 4D+1, sensors 3D

Cargo Capacity: 300 metric tons

Consumables: 8 months

Cost: 4.8 million credits (new), 2.4 million credits (used)

Hyperdrive Multiplier: x2

Hyperdrive Backup: x16

Nav Computer: Yes

Maneuverability: 2D+1

Space: 7

Atmosphere: 350: 1,000 kmh

Hull: 4D+2

Shields: 2D+1

Sensors:

Passive: 20/0D

Scan: 40/0D

Search: 80/1D

Focus: 2/2D

Weapons:

8 Turbolaser Cannons

Fire Arc: 2 front, 3 left, 3 right

Crew: 2

Scale: Capital

Skill: Capital Ship Gunnery

Fire Control: 3D

Space Range: 3-15/35/75

Atmosphere Range: 300-1.5/3.5/7.5 km

Damage: 4D+2

6 Quad Laser Cannons

Fire Arc: 3 left, 3 right

Crew: 3

Scale: Starfighter

Skill: Starship Gunnery

Fire Control: 3D

Space Range: 1-5/10/17

Atmosphere Range: 100-500/1/1.7 km

Damage: 2D

4 Concussion Missile Tubes

Fire Arc: 2 front, 2 rear

Crew: 3

Scale: Capital

Skill: Capital Ship Gunnery

Fire Control: 3D

Space Range: 1-12/30/60

Atmosphere Range: 200-1.2/3/6 km

Ammo: 30 missiles each

Damage: 9D

Capsule: The DP-20 was originally designed for the fleet of the Galactic Republic. These vessels saw extensive use among the Corellian and Rebel Alliance/New Republic fleets, although some were also seen in the hands of independent operators, such as pirate factions and other fringe groups. Local Imperial forces also utilized the class. The Rebel Alliance, in need of a small, fast attack vessel, decided to purchase a few of these starships after witnessing a group of pirates use them to successfully hijack an Imperial shipment guarded by several Imperial fighters and bombers. At least one of these vessels was wrecked in the Korteen asteroid belt by Quarg's father and his space wreckers.

CORVETTES



Addendum Personal- General Han Solo

I'm fairly certain that there were more DP-20 than anything else flying in the Rebellion fleet at one time. For the most part they have been decommissioned in the aftermath of the war; but during their prime they were a workhorse of a ship. Well-armed, well-armored, quick and maneuverable. There are still private interests that keep the DP-20 flying in the outer rim territories...

INTERCEPTOR FRIGATE

Craft: Corellian Engineering Corporation
Interceptor Frigate

Type: Interceptor Frigate

Era: Rise of the Empire, Rebellion

Affiliation: General

Source: Keith A. Kilburn

Scale: Capital

Length: 175 Meters

Skill: Capital Ship Piloting: Interceptor Frigate

Crew: 20, gunners 8, skeleton 5/+10

Passengers/Troops: 50 (troops)

Crew Skill: Astrogation 3D, Capital Ship Piloting
3D+2, Capital Ship Gunnery 4D+1, Starship

Shields 3D, Sensors 3D+1

Cargo Capacity: 5,000 Tons

Consumables: 1 Years

Hyperdrive Multiplier: x1.5

Hyperdrive Backup: x10

Nav Computer: Yes

Space: 4

Atmosphere: 280,800 kmh

Maneuverability: 1D

Hull: 3D+2

Shields: 2D

Sensors:

Passive: 50/0D+1

Scan: 90/1D+1

Search: 160/3D+1

Focus: 5/5D

Weapons:

6 Turbolasers

Fire Arc: Turret

Crew: 2

Scale: Capital

Skill: Capital ship gunnery

Fire Control: 2D

Space Range: 2-10/20/50

Atmosphere Range: 4-20/40/100 km

Damage: 5D

8 Proton Missile Launchers

Fire Arc: Front

Crew: 1

Scale: Starfighter

Skill: Starship gunner

Fire Control: 3D

Space Range: 2-10/30/60

Atmosphere Range: 2-10/30/60km

Ammo: 15 missiles each

Damage: 9D

Capsule: Though they were used by a large number of pirate groups, most Interceptor frigates bore Black Sun emblems, and some were occasionally purchased by the Alliance Fleet and Imperial Navy. Tyber Zann had a large amount of these ships modified to be faster and less armored to become Interceptor IV frigates.



Addendum Personal- General Han Solo

Leave it to the CEC to retrofit an Action VI and rebuild the whole back half in an effort to make a credit in the market place. This particular ship is popular with pirates and criminals as the Black Sun, Ploovo Two-for-One and Mee'Maw the Hutt have put them to use in their 'endeavors' and yet despite this well-known fact there is a segment of the populace that continues to buy these ships so they can feel like a 'rogue'...

KORRINA-CLASS BULK TRANSPORT

Craft: Corellian Engineering Korrina-class Bulk Transport

Type: Interceptor Frigate

Era: Rise of the Empire, Rebellion

Affiliation: General

Source: Keith A. Kilburn

Scale: Capital

Length: 175 Meters

Skill: Capital Ship Piloting: Interceptor Frigate

Crew: 20, gunners 8, skeleton 5/+10

Passengers/Troops: 50 (troops)

Crew Skill: Astrogation 3D, Capital Ship Piloting 3D+2, Capital Ship Gunnery 4D+1, Starship

Shields 3D, Sensors 3D+1

Cargo Capacity: 5,000 Tons

Consumables: 1 Years

Hyperdrive Multiplier: x1.5

Hyperdrive Backup: x10

Nav Computer: Yes

Space: 4

Atmosphere: 280,800 kmh

Maneuverability: 1D

Hull: 3D+2

Shields: 2D

Sensors:

Passive: 50/0D+1

Scan: 90/1D+1

Search: 160/3D+1

Focus: 5/5D

Weapons:

6 Turbolasers

Fire Arc: Turret

Crew: 2

Scale: Capital

Skill: Capital ship gunnery

Fire Control: 2D

Space Range: 2-10/20/50

Atmosphere Range: 4-20/40/100 km

Damage: 5D

8 Proton Missile Launchers

Fire Arc: Front

Crew: 1

Scale: Starfighter

Skill: Starship gunnery

Fire Control: 3D

Space Range: 2-10/30/60

Atmosphere Range: 2-10/30/60km

Ammo: 10 missiles each

Damage: 9D

Capsule: Though they were used by a large number of pirate groups, most Interceptor frigates bore Black Sun emblems, and some were occasionally purchased by the Alliance Fleet and Imperial Navy. Tyber Zann had a large amount of these ships modified to be faster and less armored to become Interceptor IV frigates.



Addendum Personal- General Han Solo

Leave it to the CEC to retrofit an Action VI and rebuild the whole back half in an effort to make a credit in the market place. This particular ship is popular with pirates and criminals as the Black Sun, Ploovo Two-for-One and Mee'Maw the Hutt have put them to use in their 'endeavors' and yet despite this well-known fact there is a segment of the populace that continues to buy these ships so they can feel like a 'rogue'...

NEW REPUBLIC CLASS CORVETTE

Craft: Corellian Engineering Corporation New Republic-class Corvette

Type: Corvette

Era: New Republic

Affiliation: New Republic

Source: Homemade with stats by FreddyB (rpggamer.org)

Scale: Capital

Length: 145 Meters

Skill: Capital Ship Piloting: Corellian Corvette

Crew: 135; Skeleton 32/+10

Crew Skill: Astrogation 4D+1, Capital Ship Piloting 5D+2, Capital Ship Shields 4D+1, Capital Ship Gunnery 5D+2, Sensors 5D

Passengers: 450 (Troops)

Cargo Capacity: 1,500 Tons

Consumables: 2 Years

Cost: 4.9 million credits (new); 2.8 million credits (used)

Hyperdrive Multiplier: x1

Hyperdrive Backup: x8

Nav Computer: Yes

Maneuverability: 2D

Space: 7

Atmosphere: 350; 1000 kmh

Hull: 5D

Shields: 4D

Sensors:

Passive: 50/1D

Scan: 100/2D

Search: 150/3D

Focus: 4/4D

Weapons:

16 Turbolaser Cannons

Fire Arc: Turret

Crew: 2

Scale: Capital

Skill: Capital ship gunnery

Fire Control: 3D

Space Range: 3-15/36/75

Atmosphere: 6-30/72/150 km

Damage: 5D

12 Anti-Starfighter Laser Cannons

Fire Arc: Turret

Crew: 1

Skill: Starship gunnery

Scale: Starfighter

Fire Control: 2D

Space Range: 1-5/12/25

Atmosphere: 2-10/24/50 km

Damage: 5D

Starfighter Complement: 6 Starfighters

Starship Support Compliment: 1 Shuttle

Capsule: The Corellian Corvette has served the Rebellion from its foundation as a transport, combat and courier vessel, with its powerful engines and high maneuverability. So when the Empire was defeated at Endor, and the New Republic was founded and gained legitimacy, the leaders approached the Corellian Engineering Corporation for an updated version of this fine vessel to serve the New Republic as an official vessel. The New Republic Corvette was the result which was released after a couple of years of development work, slightly faster, and much better armed, this vessel acts in a number of the same roles as the older corvette design, but is much more obviously a military vessel, with its enhanced hull armor, troop carrying capacity, and much smaller cargo hold. The New Republic has bought the vessel in reasonable numbers, where it serves alongside its older brother, and a number have also been sold to private concerns, much to the dislike of the New Republic's leadership.

CORVETTES



Addendum Personal- General Han Solo

I'll let you in on a little known fact. The New Republic Corvette got the C.E.C. into a fair amount of trouble with the New Republic Council and there were talks of potential court action as a result of the C.E.C. breaking the exclusivity contract to only manufacture the corvette for the New Republic and not sell it to outside interests. Admiral Ackbar wants to have them brought up on treason charges and has vowed to do it if he catches wind of the Imperials purchasing the Corvette...

Q-SHIP

AUXILIARY CARRIER MK-I

Craft: Corellian Engineering Corporation
Auxiliary Carrier

Type: Escort Carrier

Era: Galactic Empire, New Republic

Affiliation: Alliance, Imperial Remnant

Source: crmcneill

Scale: Capital

Length: 125 Meters

Skill: Space Transport Piloting: Auxiliary Carrier

Crew: 66 (10 @ +10) & 4 Gunners

Crew Skill: Astrogation 3D, Capital Ship Shields 2D+2, Sensors 3D, Starship Gunnery 3D, Space Transports 3D

Passengers: 20 (Troops)

Cargo Capacity: 1000 Tons

Consumables: 6 Months

Cost: Not available for sale

Hyperdrive Multiplier: x2

Hyperdrive Backup: x12

Nav Computer: Yes

Maneuverability: 1D

Space: 4

Atmosphere: 225; 650 kmh

Hull: 4D

Shields: 2D

Sensors:

Passive 40/1D

Scan 80/2D

Search 100/2D+2

Focus 4/3D

Weapons:

4 Twin Laser Cannons

Fire Arc: 1 Front, 1 Left, 1 Right, 1 Rear

Crew: 1

Scale: Starfighter

Skill: Starship Gunnery

Fire Control: 3D

Space Range: 1-3/12/25

Atmosphere Range: 100-300/1.2/2.5 km

Damage: 5D

Small Craft Complement: 12 starfighters, 2 pinnaces

Special Rule:

Ambush: If an enemy is in combat range, any starfighters launched from the ship receive a one-time, +2D bonus to initiative for their first round of combat. Any enemy craft that loses its initiative roll by more than 10 points is considered surprised, and may not react to attacks that round. If the use of this tactic has become well known, or the enemy starfighters have faced this tactic before, the bonus is reduced to +1D.

Capsule: The Auxiliary Carrier is based on the well-known Action VI bulk freighter design, and it looks exactly like one from the outside. However, it is heavily modified to take military hardware such as armor, weapons, a full sensor suite, and facilities to carry one starfighter squadron. All of the ship's weapons are concealed behind retracting panels, and the mounts and launch bays are sensor baffled to fool enemy sensors.

The modus operandi for the Auxiliary Carrier is to function as a convoy escort vessel, and its resemblance to a real bulk freighter makes it look more vulnerable than it is. The ship will behave just like a bulk freighter until attacking starfighters are close by, then launch its starfighters into battle with as little warning as possible. Since its introduction by the Empire, the Alliance has suffered increased starfighter losses when making attacks against convoys which they thought were only lightly protected.

CORVETTES



Addendum Personal- General Han Solo

Ever since Grand Admiral Thrawn pulled this trick, the New Republic has been scrambling to play catch up by adopting the tactic by fabricating numerous ships to be able to pull off the same surprise attack, should the need ever arise...

Q-SHIP

AUXILIARY CRUISER MK-II

Craft: Corellian Engineering Corporation

Auxiliary Cruiser

Type: Escort Gunship

Era: Rise of the Empire, Rebellion, New Republic

Affiliation: Galactic Empire, Imperial Remnant

Source: crmcneill

Scale: Capital

Length: 125 Meters

Skill: Space Transports: Auxiliary Cruiser

Crew: 66 (10 @ +10) & 42 Gunners

Crew Skill: Astrogation 3D, Capital Ship Shields

2D+2, Sensors 3D, Capital Ship Gunnery 3D,

Space Transports 3D

Passengers: 20 (Troops)

Cargo Capacity: 1000 tons

Consumables: 6 Months

Cost: Not available for sale

Hyperdrive Multiplier: x2

Hyperdrive Backup: x12

Nav Computer: Yes

Maneuverability: 1D

Space: 4

Atmosphere: 225; 650 kmh

Hull: 4D

Shields: 2D

Sensors:

Passive 40/1D

Scan 80/2D

Search 100/2D+2

Focus 4/3D

Weapons:

8 Turbolaser Cannon

Fire Arc: 2 Front, 3 Left, 3 Right

Crew: 2

Scale: Capital

Skill: Capital Ship Gunnery

Fire Control: 2D

Space Range: 3-15/35/75

Atmosphere Range: 300-1.5/3.5/7.5 km

Damage: 4D

2 Heavy Ion Cannon

Fire Arc: 1 Left, 1 Right

Crew: 2

Scale: Capital

Skill: Capital Ship Gunnery

Fire Control: 4D

Space Range: 1-10/25/50

Atmosphere Range: 100-1/2.5/5 km

Damage: 4D (ionization)

4 Proton Torpedo Tubes

Fire Arc: 2 Left, 2 Right

Crew: 3

Scale: Capital

Skill: Capital Ship Gunnery

Fire Control: 2D

Space Range: 1/3/7

Atmosphere Range: 0-100/300/700 km

Ammo: 8 per launcher

Damage: 9D

4 Twin Laser Cannons

Fire Arc: 1 Front, 1 Left, 1 Right, 1 Rear

Crew: 1

Scale: Starfighter

Skill: Starship Gunnery

Fire Control: 3D

Space Range: 1-3/12/25

Atmosphere Range: 100-300/1.2/2.5 km

Damage: 5D

2 Tractor Beam Projectors

Fire Arc: Turret

Crew: 3

Scale: Capital

Skill: Capital Ship Gunnery

Fire Control: 3D

Space Range: 1-5/15/30

Atmosphere Range: 100-500/1.5/3 km

Damage: 5D

Small Craft Complement: 2 pinnaces

Special Rule:

Ambush: If an enemy is in combat range, the ship receive a one-time, +2D bonus to initiative for its first

CORVETTES

round of combat. Any enemy craft that loses its initiative roll by more than 10 points is considered surprised, and may not react to attacks that round. If the use of this tactic has become well known, or the enemy ships have faced this tactic before, the bonus is reduced to +1D.

Capsule: The Auxiliary Cruiser is based on the well-known Action VI bulk freighter design, and it looks exactly like one from the outside. However, like its sibling, the Auxiliary Carrier, appearances are deceiving. The Auxiliary Cruiser has received many of the same system upgrades as the Carrier, but instead of starfighters, this ship conceals a powerful weapons suite, one which can be deadly to small capital ships if they are caught unaware at close range. All of the ship's weapons are concealed behind retracting panels, and the mounts themselves are sensor baffled to fool enemy sensors.

The modus operandi for the Auxiliary Cruiser is to function as a convoy escort vessel, and its resemblance to a real bulk freighter makes it look more vulnerable than it is. The ship will behave just like a bulk freighter until attacking forces close the range, then unleash a massive broadside with as little warning as possible. Since its introduction by the Empire, the Alliance has suffered increased losses when making attacks against convoys which they thought were only lightly protected. Auxiliary Cruisers have a tertiary effect above and beyond any actual combat capability; the Imperial Navy has noticed a statistical decrease in pirate attacks if auxiliary carriers and cruisers are known to be operating in a sector, regardless of whether or not a given convoy has an auxiliary escort or not.



Addendum Personal- General Han Solo

See my remarks for the Mark I...

RANGER-CLASS GUNSHIP

Craft: Corellian Engineering Corporation *Ranger*-class gunship

Type: Anti-piracy and patrol vessel

Affiliation: New Republic, Galactic Alliance

Era: New Jedi Order, Legacy

Source: wookieepedia, stats by +Oliver Queen

Scale: Capital

Length: 150 meters

Skill: Capital ship piloting: *Ranger*-class

Crew: 35, gunners: 16, skeleton: 4/+10

Passengers: 15 (troops), up to 25 prisoners

Cargo Capacity: 250 metric tons

Consumables: 1 week

Cost: Not available for sale

Hyperdrive Multiplier: x2

Hyperdrive Backup: x15

Nav Computer: Yes

Maneuverability: 2D

Space: 6

Atmosphere: 330; 950 kmh

Hull: 4D

Shields: 2D

Sensors:

Passive: 50/1D

Scan: 100/1D

Search: 120/2D

Focus: 5/2D+1

Weapons:

2 Quad Turbolaser Cannons

Fire Arc: 1 (front, left, rear), 1 (front, right, rear)

Crew: 3

Scale: Capital

Skill: Capital ship gunnery

Fire Control: 3D

Space Range: 3-20/40/80

Atmosphere Range: 6-40/80/160 km

Damage: 4D+2

5 Quad Laser Cannons

Fire Arc: 3 Turrets, 2 (left, right, rear)

Crew: 2

Scale: Starfighter

Skill: Starship gunnery

Fire Control: 2D

Space Range: 1-5/10/20

Atmosphere Range: 2-10/20/40 km

Damage: 5D

Capsule: The *Ranger*-class gunship was a type of gunship manufactured by the Corellian Engineering Corporation and used by the New Republic Defense Fleet during the Yuuzhan Vong War. Following the Pel-laeon–Gavrisom Treaty, the New Republic Defense Fleet began to focus its efforts on eradicating pirate and smuggler threats in the Outer Rim Territories. As such, the Fleet required a vessel capable of engaging small to mid-sized starships while matching the speed of outlaw vessels. The *Ranger*-class was designed to fill that role specifically, and proved effective with its powerful turbolaser cannons and "hi-track" quad laser batteries. The design principles were based on the Lancer-class frigate.

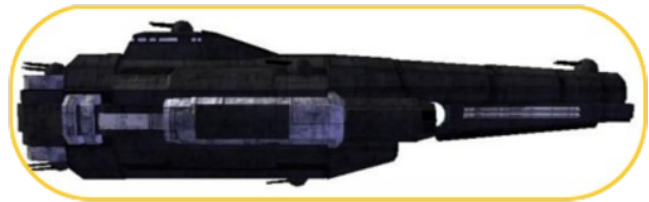

Addendum Personal- General Han Solo

I remember the Ranger; it was a decent gunship, but the less said about the Yuuzhan Vong War the better... There was a lot of misinformation and rumors to come out of that nightmare, I mean who ever heard of dropping a moon on someone...

REPUBLIC CLASS CRUISER

Craft: Corellian Engineering Corporation
Republic-class Cruiser

Type: Cruiser

Era: Old Republic

Affiliation: General

Source: FreddyB (rpggamer.org)

Scale: Capital

Length: 115 Meters

Skill: Capital Ship Piloting - Republic Cruiser

Crew: 40; Skeleton **Crew:** 15/+10

Crew Skill: Capital Ship Piloting 4D, Astrogation
4D

Passengers: 40

Consumables: 1 Year

Cost: 500,000 credits (used)

Cargo Capacity: 2,000 tons

Hyperdrive Multiplier: x2

Hyperdrive Backup: No

Nav Computer: Yes

Space: 5

Atmosphere: 305; 875 kmh

Maneuverability: 2D

Hull: 5D

Shields: 3D

Sensors:

Passive: 30/0D

Scan: 60/1D

Search: 80/2D

Focus: 4/3D

Capsule: The CEC Republic Cruiser was a variant of the *Counselor*-class vessel designed and designed as a civilian transport sold exclusively by the Corellian Engineering Corporation to the Old Republic, The Re-

public Cruiser shows a number of similarities to the Corellian Corvette including high speed, maneuverability and shields, in fact although the Republic Cruiser is not armed, it has an extremely tough hull and powerful shields for a ship of its size. This has led to Republic Cruisers being much valued ships by free captains and traders, since their weapon free status can be changed by simple modifications and even though their cargo space is limited their toughness is much prized. Republic Cruisers were retired from service as the Clone Wars started when they became obvious targets for the Confederacy to strike at, and armed vessels such as the Corellian Corvette were used instead.



Addendum Personal- General Han Solo

If you're thinking that you saw the specs for this ship a while back in the book, then you'd be right. It seems that the designer simply rehashed this ship from an existing design and simply put a new name on the vessel before trying to get it out on to the market. It problem worked at the time, I mean it worked with Action line, so why couldn't it work with the Consular cruisers and Republic cruisers too?

REPUBLIC

AMBASSADORIAL CRUISER

Craft: Corellian Engineering Corporation's Republic Ambassadorial Cruiser

Type: Diplomatic envoy and ambassadorial transport

Era: Old Republic, Rise of the Empire

Affiliation: Galactic Republic, Galactic Empire

Source: Keith Kilburn

Scale: Capital

Length: 110 meters

Skill: Capital ship piloting: Republic ambassadorial cruiser

Crew: 8; Skeleton: 2/+15

Crew Skill: Varies dramatically

Passengers: 24

Cargo Capacity: 550 metric tons

Consumables: 1 year

Cost: Not available for sale

Hyperdrive Multiplier: x3

Hyperdrive Backup: x10

Nav Computer: Yes

Maneuverability: 1D+2

Space: 6

Atmosphere: 330; 950 kmh

Hull: 3D+2

Shields: 1D+1

Sensors:

Passive: 35/1D

Scan: 70/2D

Search: 90/3D

Focus: 3/3D+2

Capsule: The direct predecessor to the *Consular*-class cruiser, the peaceful Republic ambassadorial cruiser was primarily for senatorial fact-finding missions, critical negotiations or the occasional deep space border negotiation. The Republic cruiser often served

as a neutral meeting ground for Republic officials and leaders of groups in conflict. The entire front salon pod could eject from the cruiser with its own sensors and independent life-support gear ready to sustain the diplomatic party on board.

The color of the Republic ambassadorial cruiser sends a message to all who see it. Red is the color of ambassadorial relations and neutrality for spacecraft of the Galactic Republic, and has been for generations. This tradition would carry on even into the days of the Empire: Princess Leia Organa's consular vessel *Tantive IV* of Alderaan is striped in red to indicate its special diplomatic status. Republic ambassadorial cruisers must often rely on their reputations as absolutely secure vessels for high-level diplomatic meetings and confrontations. For security reasons, crew is kept to a bare minimum, with many ship functions attended by simple utility droids.



Addendum Personal- General Han Solo

By the beginning of the Clone Wars the ambassadorial cruiser had all but been phased out and replaced by the Consular-class cruiser. Some of the safety features were nice, such as the control pod being an oversized escape pod, but the lack of weaponry makes me nervous when walking into hostile territory...

REPUBLIC

PATROL CRUISER

Craft: Corellian Engineering Corporation's Patrol Cruiser

Type: Armed space cruiser

Era: Old Republic (72 BBY)

Affiliation: Galactic Republic

Source: Ryan Matheny (rpggamer.org)

Scale: Capital

Length: 115 meters

Skill: Capital ship piloting: Republic cruiser

Crew: 8; gunners: 8; skeleton: 2/+15

Crew Skill: Capital ship piloting 4D, capital ship gunnery 4D, starship gunnery 4D

Passengers: 8 (troops)

Cargo Capacity: 50 metric tons

Consumables: 1 year

Cost: Not available for sale

Hyperdrive Multiplier: x3.2

Hyperdrive Backup: No

Nav Computer: Yes

Maneuverability: 1D+2

Space: 6

Atmosphere: 330; 950 kmh

Hull: 3D

Shields: 1D

Sensors:

Passive: 35/1D

Scan: 70/2D

Search: 90/3D

Focus: 3/3D+2

Weapons:

2 Turbolaser Cannons (fire-linked)

Fire Arc: Front

Crew: 4

Scale: Capital

Skill: Capital ship gunnery

Fire Control: 2D

Space Range: 3-15/35/75

Atmosphere Range: 6-30/70/150 km

Damage: 3D

2 Quad Laser Cannons

Fire Arc: 1 dorsal turret, 1 ventral turret

Crew: 2

Scale: Starfighter

Skill: Starship gunnery

Fire Control: 2D

Space Range: 1-3/12/25

Atmosphere Range: 100-300/1.2/2.5 km

Damage: 4D

Capsule: While the diplomatic cruisers carry a formal conference room within their salon pod, the patrol cruisers' salon pods were entirely turbolasers and targeting sensors with a cramped space for the gunners. The patrol cruisers also boast a pair of Corellian quad laser cannon turrets for point defense against starfighters and other small starships. These patrol cruisers were most commonly found as light escorts for convoys and larger warships but many served as system defense and patrol vessels, policing a localized area of space and protecting against piracy and small time smuggling.



Addendum Personal- General Han Solo

The Patrol cruiser was sold in mass to local, sector and galactic law-enforcement. It was also used by clones during the Clone Wars to keep things from getting out of hand in outer rim border areas. Surprisingly

CORVETTES

there are still some patrol cruisers in use, mostly in the Corellian System and to a lesser degree by the ESPO in the Corporate Sector. The patrol cruisers aren't overly tough, but they pack a nasty punch. If you can avoid the fight I'd recommend it...

STAR HAULER CLASS DRONE BARGE

Craft: Corellian Engineering Corporation
Starhauler-class Drone Barge
Type: Medium bulk freighter
Era: Rise of the Empire
Affiliation: General
Source: wookieepedia, stats by +Oliver Queen
Scale: Starfighter
Length: 135 meters
Skill: Space transports: *StarHauler-class*
Crew: None (piloted by droid brain)
Crew Skill: Space transport piloting 4D,
communications 3D, repulsorlift ops 3D
Cargo Capacity: up to four external cargo
containers (typically 20 metric tons each)
Consumables: None
Cost: 1 million credits (new), 825,000 credits
(used)
Hyperdrive Multiplier: x2
Hyperdrive Backup: None
Nav Computer: No (navigation tape, 1 jump)
Space: 2
Atmosphere: 225; 650 kmh
Hull: 3D+2
Shields: 1D
Sensors:
Passive: 15/0D
Scan: 30/1D
Search: 40/2D
Focus: 2/2D

Game Notes: There were two variant Starhauler-class drone barges. The Starhauler 131-SX2 was an ore and scrap hauler. The Starhauler 131-T3 was used for fluid and liquid transport. The only difference between

the ships is the accompanying, detachable cargo containers. The containers themselves were each very different, depending on the load. Strangely Corellian Engineering Corporation never made the clamping mechanism universal.

Capsule: The *Starhauler*-class drone barge was a long line of starships made by the Corellian Engineering Corporation. It produced more than 24 different versions of the starship. Like other drone barges, the *Starhauler*-class had no living quarters or life-support systems though their cramped corridors could sustain a limited atmosphere. However, these vessels were more vulnerable to accidents or piracy than those with organic crews.

On large starship manufacturing worlds, the Starhaulers would remain at surface landing pads when not making runs due to their gigantic size. Over a series of days, both the internal cargo holds and the external tanks would be loaded with industrial waste generated by shipyard construction or resource mining. When these vessels reached their full capacity, they would lift off en masse using both their repulsors and sublight engines to make their way to wherever their automated beacon was located.



Addendum Personal- General Han Solo

I've got nothing really to say about the Starhauler, only because they function just like the specifications say that they do...

SUPERLIFT

ORE HAULER



Craft: Corellian Engineering Superlift Ore Hauler

Type: Medium ore hauler

Era: Old Republic

Affiliation: General

Source: Pirates & Privateers (pages 69-70),
Flashpoint! Brak Sector (page 30)

Scale: Capital

Length: 155 meters

Skill: Space transports: Superlift hauler

Crew: 10, skeleton: 5/+5

Crew Skill: Varies widely

Passengers: 5

Cargo Capacity: 90,000 metric tons

Consumables: 3 months

Cost: 1.5 million credits (new), 500,000 credits
(used)

Hyperdrive Multiplier: x4

Hyperdrive Backup: x20

Nav Computer: Limited to 4 jumps

Space: 2

Atmosphere: 225; 650 kmh

Hull: 2D+2

Shields: 1D

Sensors:

Passive: 20/0D

Scan: 30/1D

Search: 40/1D+2

Focus: 1/2D

Capsule: The Superlift Ore Hauler features an enormous, cavernous cargo hold for transporting both raw ore and cargo containers. Its dimensions allow for both deep space and planetary surface cargo loading. Additionally, this general purpose hauler is suitable for interplanetary hops. Pirates consider this vessel to be the ideal prize due to its lack of arms, almost non-existent shields, sluggish nature, and miniscule crew. For this reason, many of these ships are escorted to and from their destinations.

Addendum Personal- General Han Solo

Okay, that last comment got me into some trouble with the editor of the book so I have been asked to say something about the Ore Hauler in an effort to entice the reader to want to know more. They are slow, bulky and fly like an Ewok hurled through the air by an angry Wookiee. If you need to stop suddenly or alter your course in a way that requires speed and dexterity, then you're doomed. Sacrifice some cargo capacity and arm this thing to the teeth before you take it out into the universe...

CHAPTER 14

FRIGATES

<Translated from Shyriiwook, by C-3PO, human/cyborg relations...>

Auzituck
Grandfather of Chewbacca

Greetings, I am Chewbacca the Wookiee, noble member of the 'Bacca' clan, son of Attichitcuk, husband to Mallatobuck, Father to Lumpawaroo and cousin to Krazah. From my noble ancestors I carried the name of the ancient Wookiee hero, the great Bacca, first of the great chieftains of Kashyyyk and creator of 'Bacca's blade', an honor blade that denotes leadership among wookiee clans. The blade was crafted 42...

So in closing, it is best to use a frigate in a support capacity, rather than as a slave transport. Wookiees have been known to pull people's arms out of socket, so we should let the Wookiees win...

Chewbacca
Life-debted partner to Han Solo.

(The translation temporarily stops as the Wookiee growls and barks at the droid.)

I was just trying to add a bit of culture...

(The translation stops again as the Wookiee growls and barks at the droid.)

Fine, I'll just translate for you, you just see if I offer to improve your recording anymore. Why I was just made to suffer, it seems to be my lot in life...

(The translation stops once more as the Wookiee growls and barks at the droid.)

As I was saying, before I was rudely interrupted, a frigate is a type of military ship designed to serve in a protective capacity during battles in a general supportive role. Typically a frigate carries a crew between two hundred and one thousand sentient beings and is approximately between two and four hundred meters in length, although I am told that crew capacity and length values vary as there are vessels that are both larger and smaller that fit into the frigate classification. Chewbacca says that his knowledge of such vessels comes from his days as a slave for the Empire; and he remembers his grandfather speaking out about their enslavement.

“Our people’s lives were destroyed when the Trandoshans sold us into slavery. The last of our clan was taken from Kashyyk to the Imperial slave houses, where they tried to take the last of our dignity as well. They stripped us of our families and our names. They treated us like animals and pushed us into these frigates to take us among the stars, never knowing that one day we will return to our home and free it from the Empire.”

CC-2200

INTERDICTION FRIGATE

Craft: Corellian Engineering Corporation CC-2200

Type: Hyperspace Interdiction Frigate

Era: Rebellion, New Republic, New Jedi Order

Affiliation: Alliance to Restore the Republic, New Republic

Source: Star Wars : Rebellion video game, stats by crmcneill

Scale: Capital

Length: 400 meters

Skill: Capital Ship Piloting: CC-2200

Crew: 1,050 (500 @ +10), plus 71 gunners

Crew Skill: *Astrogation* 3D+2, *Capital Ship Gunnery* 4D+2, *Capital Ship Piloting* 4D+1, *Capital Ship Shields* 4D, *Sensors* 4D+1

Passengers: 150 (troops)

Cargo Capacity: 5,000 metric tons

Consumables: 1 year

Hyperdrive Multiplier: x1

Hyperdrive Backup: x12

Nav Computer: Yes

Maneuverability: 2D

Space: 6

Hull: 4D+2

Shields: 3D

Sensors:

Passive: 30/0D

Scan: 50/1D

Search: 100/2D

Focus: 4/3D

Weapons:

10 Turbolaser Cannon

Fire Arc: 2 front, 3 right, 3 left, 2 back

Crew: 3

Scale: Capital

Skill: Capital Ship Gunnery

Fire Control: 1D

Space Range: 3-15/35/75

Atmosphere Range: 6-30/70/150 km

Damage: 5D

20 Laser Cannon

Fire Arc: 5 front, 5 left, 5 right, 5 back

Crew: 2

Scale: Capital

Skill: Capital Ship Gunnery

Fire Control: 3D

Space Range: 1-3/12/25

Atmosphere Range: 2-6/24/50km

Damage: 4D

Gravity Well Generator

Fire Arc: All

Crew: 1

Scale: Capital

Skill: Capital ship gunnery

Effect: Rather than projecting a gravity well, this first generation interdiction platform simply generates a gravity well centered on the ship itself. If a ship is within 10 units of the generator, it cannot jump into hyperspace. If a ship is beyond 10 units, it suffers a -40 penalty to its *Astrogation* roll, decreasing by -5 for every additional 10 units of distance from the generator.

Time To Use: Once activated, a gravity well generator requires 8 rounds to come on line. It can be turned off immediately.

Note: When active, the Gravity Well Generator draws so much power that it drastically affects the ship's performance. Reduce Space to 2 and Maneuverability to 0D.

Capsule: A predecessor to the CC-7700, the Detainer CC-2200 uses the same hull type, visually differing only in that it lacks the CC-7700's bow mounted gravity well linear projection array. Introduced near the end of the Clone Wars, the Detainer saw common usage. In the Rebellion era, however, the Detainer is long past its prime, replaced by the CC-7700 and the newer Immobilizer 418. Detainers do, however, still see usage in low-priority sectors and with some Rebel Alliance

FRIGATES

units, even though the ship's gravity well generator doesn't fit particularly well with Alliance capital ship operations. However, some Detainers have made it into the hands of pirate groups, and the ship is a perfect fit for the "barricade" tactic. All Detainers have been upgraded with stronger shields over the years, as the ship's modus operandi tends to make it an obvious target.



Addendum Personal- General Han Solo

The CC-line of ships are nasty pieces of work designed by the C.E.C. to stop the Imperials dead in the tracks and inflict the maximum amount of damage on them in the shortest amount of time. War is never a pretty thing and over the years I have fought because I had to. It wasn't until later that I fought because I found something worth protecting. The '2200 made it too easy to fight that war...

CC-5500

FRIGATE

Model: Corellian CC-5500 Frigate

Type: Escort frigate

Era: Rebellion, New Republic, New Jedi Order

Affiliation: New Republic

Source: Ryan Matheny (rpggamer.org)

Scale: Capital

Length: 200 meters

Crew: 175, gunners: 20, skeleton: 30

Passengers: 40 (troops)

Cargo Capacity: 5,000 metric tons

Consumables: 8 months

Cost: Not available for sale

Hyperdrive Multiplier: x2

Hyperdrive Backup: x15

Nav Computer: Yes

Maneuverability: 1D

Space: 7

Atmosphere: 330; 950 kmh

Hull: 3D+2

Shields: 2D+1

Sensors:

Passive: 25/1D

Scan: 85/2D

Search: 100/3D

Focus: 3/4D

Weapons:

4 Turbolaser Turrets

Fire Arc: 2 dorsal, 2 ventral

Crew: 1

Scale: Starfighter

Skill: Starship gunnery

Fire Control: 2D

Space Range: 3-15/35/75

Atmosphere Range: 6-30/70/150 km

Damage: 4D

14 Quad Laser Turrets

Fire Arc: 9 dorsal, 5 ventral

Crew: 1

Scale: Starfighter

Skill: Starship gunnery

Fire Control: 2D

Space Range: 1-3/12/25

Atmosphere Range: 100-300/1.2/2.5 km

Damage: 5D

Capsule: The Corellian CC-5500 frigate was designed as a cheaper alternative to the extremely popular Kuati Nebulon B frigates. While it lacked the firepower and tractor beam projectors of the Nebulon B, the CC-5500 was much more affordable and far easier to maintain. Like almost every other starship ever designed and manufactured by Corellian Engineering Corporation, the CC-5500 was also very easily modified which made it popular among planetary defense fleets and private corporations, as each ship could be modified according to the needs of the owners and the specific mission roles it would fill.

In its stock form, the CC-5500 was a deadly and swift anti-starfighter platform, armed with fourteen powerful quad laser cannon turrets. For ship-to-ship confrontations, the CC-5500 was equipped with four moderately powered turbolaser cannons which were mainly intended to be used against smaller vessels such as gunships or bulk transports. The CC-5500 made its first appearance just shortly after the Nebulon-B frigate hit the market. With a price tag approximately half of the Nebulon-B, Corellian saw decent sales of the model, but the overall firepower of the Nebulon-B made it the more popular of the two.

The Empire fielded a good number of these vessels in their stock form as escorts for low risk convoys. The Alliance, which happily took quite a few CC-5500s off of the Empire's hands, was known to extensively modify the vessels into commerce raiding platforms - sometimes pitting one CC-5500 against another. The CC-5500 never saw extensive use during the Rebellion or post Rebellion years. As the New Republic developed, many ships were taken out of service to make room for newly designed vessels which would serve with distinction during the Black Fleet Crisis and the Vong invasion. A few were kept in service in the outer rim, others converted into customs vessels, but the bulk

of the New Republic's CC-5500s were sold off of the Corporate Sector Authority.



Addendum Personal- General Han Solo

I can tell you from experience that you rarely need 14 weapon placements on an escort frigate. It's just overkill. I love how the sales pitch talks about us 'pitting one CC-5500 against another' like it was some sort of gladiatorial fight to the death with the C.E.C. cheering us on. Take it from someone who spent a good portion of his life being shot at, more guns on a ship rarely makes things all better...

CC-7700

FRIGATE

Craft: Corellian Engineering Corporation's CC-7700 Frigate

Type: Light interdiction vessel

Era: New Republic

Affiliation: New Republic

Source: Ryan Matheny (rpggamer.org)

Scale: Capital

Length: 180 meters

Skill: Capital Ship Piloting: CC-7700 Frigate

Crew: 56, gunners: 35, skeleton: 15/+15

Crew Skill: Astrogation 3D+1, capital ship gunnery 4D+2, capital ship piloting 4D, capital ship shields 4D+1, sensors 3D

Cargo Capacity: 300 metric tons

Consumables: 4 months

Cost: Not available for sale

Hyperdrive Multiplier: x2

Hyperdrive Backup: x16

Nav Computer: Yes

Maneuverability: 1D+2

Space: 6

Hull: 3D

Shields: 3D

Sensors:

Passive: 15/0D

Scan: 35/0D

Search: 70/1D

Focus: 2/2D

Weapons:

5 Turbolaser Batteries

Fire Arc: 1 front, 2 left, 2 right

Crew: 2

Scale: Capital

Skill: Capital Ship Gunnery

Fire Control: 3D

Space Range: 3-15/35/75

Atmosphere Range: 6-30/70/150 km

Damage: 4D+2

24 Laser Cannons

Fire Arc: 6 front, 9 left, 9 right, 9 back

Crew: 1

Scale: Starfighter

Skill: Starship Gunnery

Fire Control: 3D

Space Range: 1-5/10/17

Atmosphere Range: 100-500/1/1.7 km

Damage: 3D+2

Gravity Well Projectors

Fire Arc: Turret

Crew: 1

Scale: Capital

Skill: Capital ship gunnery

Fire Control: 6D

Space Range: 1-5/75/150

Atmosphere Range: 2-10/1.5/3 km

Damage: Blocks hyperspace travel

Capsule: The CC-7700 is an older sibling to the Corellian gunship. While lightly armed, the CC-7700 is designed mainly as a platform for a gravity well projector. The function of this vessel is to prevent the withdrawal of enemy vessels from a battle. The CC-7700 is a rarity among the Alliance forces and the exact number in the Fleet is a closely guarded secret along with their location.



Addendum Personal- General Han Solo

'Lightly armed'? Twenty-nine gun placements is 'lightly armed'? Who writes this stuff?

CC-9600

FRIGATE

Craft: Corellian Engineering Corporation's CC-9600 Frigate

Type: Medium frigate

Era: New Republic

Affiliation: New Republic

Source: Ryan Matheny (rpggamer.org)

Scale: Capital

Length: 168 meters

Skill: Capital Ship Piloting: CC-9600 Frigate

Crew: 36, gunners: 46, skeleton: 10/+15

Crew Skill: Astrogation 3D+1, capital ship gunnery 4D+2, capital ship piloting 4D, capital ship shields 4D+1, sensors 3D

Passengers: 80 (troops)

Cargo Capacity: 1,000 metric tons

Consumables: 6 months

Cost: Not available for sale

Hyperdrive Multiplier: x2

Hyperdrive Backup: x16

Nav Computer: Yes

Maneuverability: 2D

Space: 6

Hull: 3D+1

Shields: 3D+2

Sensors:

Passive: 15/0D

Scan: 35/0D

Search: 70/1D

Focus: 2/2D

Weapons:

34 Light Turbolaser Cannons

Fire Arc: 6 front, 12 left, 12 right, 4 back

Crew: 1

Scale: Capital

Skill: Capital Ship Gunnery

Fire Control: 3D+1

Space Range: 3-15/35/75

Atmosphere Range: 6-30/70/150 km

Damage: 4D

12 Ion Cannons

Fire Arc: 4 front, 4 left, 4 right

Crew: 1

Scale: Capital

Skill: Capital ship gunnery

Fire Control: 3D

Space Range: 1-10/25/50

Atmosphere: 2-20/50/100 km

Damage: 3D

Capsule: The CC-9600 is the latest iteration of the CC series of capital ships. It is more compact and requires a smaller crew than the earlier CC-7700 model. While the CC-7700 was primarily a platform for a gravity well projector the CC-9600 is a dedicated combat starship. The firepower and shielding of the CC-9600 are considerable, while increasing cargo space and allowing room to carry troops on board.



Addendum Personal- General Han Solo

I like how this information capsule mentions the CC-7700 is primarily a platform for a grav-well generator and the CC-9600 is a dedicated combat ship. So I guess the difference is that the CC-9600 has five more weapon placements and a dozen ion cannons. Guess the CC-7700 designers were foolin' around...

CHASEMASTER CLASS FRIGATE

Craft: Corellian Engineering Corporation Frigate

Type: Frigate

Era: Old Republic

Affiliation: Keshiri Sith, Old Republic, General

Source: stats by +Oliver Queen, image by Drone04.

Scale: Capital

Length: 215 meters

Skill: Capital ship piloting: ChaseMaster

Crew: 40; 26 gunners

Crew Skill: Astrogation 3D, capital ship gunnery 3D+2, capital ship piloting 3D, capital ship shields 3D, capital ship repair 3D, sensors 3D+1

Passengers: 75 troops

Cargo Capacity: 6,000 metric tons

Consumables: 1 year

Cost: Not for sale

Hyperdrive Multiplier: x2

Hyperdrive Backup: x12

Nav Computer: Yes

Space: 5

Maneuverability: 1D

Hull: 4D

Shields: 2D

Sensors:

Passive: 40/1D

Scan: 70/2D

Search: 100/3D

Focus: 4/3D+2

Weapons:

6 Turbolaser Cannons

Fire Arc: 4 front, 2 turret

Crew: 3

Scale: Capital

Skill: Capital ship gunnery

Fire Control: 2D+1

Space Range: 3-15/35/75

Atmosphere Range: 6-30/70/150 km

Damage: 4D

2 Laser Cannons

Fire Arc: Turret

Crew: 2

Scale: Starfighter

Skill: Starship gunnery

Fire Control: 2D

Space Range: 1-3/12/25

Atmosphere Range: 2-6/24/50 km

Damage: 5D

Dual-Concussion Missile Launcher

Fire Arc: front

Crew: 3

Scale: Capital

Skill: Capital ship gunnery

Fire Control: 3D

Space Range: 2-12/30/60

Atmosphere Range: 200-1.2/3/6 km

Ammo: 10 missiles each

Damage: 9D

Tractor Beam Projector

Fire Arc: Turret

Crew: 3

Scale: Capital

Skill: Capital ship gunnery

Fire Control: 2D+2

Space Range: 1-5/15/30

Atmosphere Range: 2-10/30/60 km

Damage: 4D

Landing Bay: 1

Ship Complement: 2 squadrons starfighters (24)

Capsule: The Chasemaster Frigate is an older ship that has been stolen and refitted for front line duty until heavier ships could be built or stolen to replace it.

FRIGATES

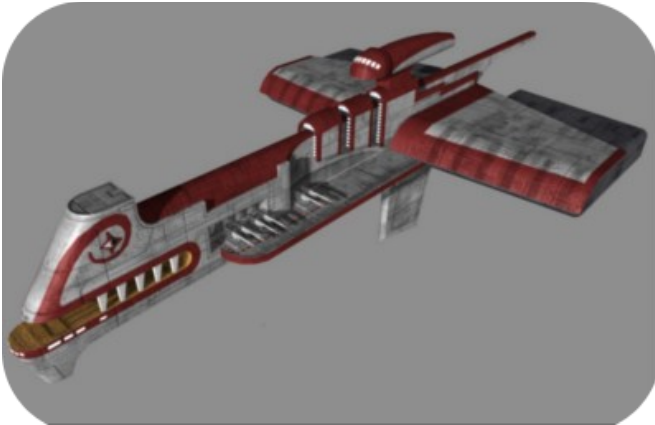

Addendum Personal- General Han Solo

I've seen conflicting information about where this ship design came from. One version says the C.S.A. designed it while another says it was the C.E.C. All I know for certain is that the two parties have been going at each other in the courts over copyright infringements. Each claiming the two vehicles were 'independently' designed...

FR-5

REPUBLIC FRIGATE

Craft: Corellian Engineering Corporation FR-5 Republic Frigate
Type: Frigate
Era: Old Republic: Great Sith War (93396 BBY)
Affiliation: Galactic Republic
Source: FreddyB (rpggamer.org)
Scale: Capital
Length: 245 Meters
Skill: Capital Ship Piloting: Republic Frigate
Crew: 692; Skeleton **Crew:** 240/+10
Crew Skill: Astrogation 4D+1, Capital Ship Piloting 5D+2, Capital Ship Shields 4D+1, Capital Ship Gunnery 5D+2, Sensors 5D
Passengers: 60 (Troops)
Cargo Capacity: 2,000 Tons
Consumables: 1 Year
Cost: 2.1 Million (used)
Hyperdrive Multiplier: x4
Hyperdrive Backup: x24
Nav Computer: Yes
Maneuverability: 1D
Space: 5
Atmosphere: 300, 900 kmh
Hull: 4D
Shields: 1D
Sensors:
Passive: 25/0D
Scan: 50/1D
Search: 100/2D
Focus: 2/4D
Weapons:
2 Turbolaser Cannons
Fire Arc: Front
Crew: 2
Scale: Capital
Fire Control: 2D
Space Range: 2-10/24/60

Atmosphere Range: 4-20/48/120 km

Damage: 3D

4 Twin Laser Cannons

Fire Arc: Turret

Crew: 1

Scale: Starfighter

Fire Control: 2D

Space Range: 1-2/10/20

Atmosphere Range: 1-2/10/20 Km

Damage: 4D

Tractor Beam Projector

Fire Arc: Turret

Crew: 3

Scale: Capital

Fire Control: 3D

Space Range: 1-5/15/30

Atmosphere Range: 2-10/30/60 km

Damage: 4D

Capsule: After the chaos of the Sith War caused by Exar Kun and Ulic Quel-Droma the newly solidified Republic started to form a powerful fleet using the latest technology. The Republic Frigate was one of the classes of vessels that were put into service, provided by the Corellian Engineering Corporation, and put into service in time for the Mandalorian Wars. A fleet of these vessels and their companion gunships under the command of the Jedi Malak and Revan fought against the invading Mandalorians who thought they were taking advantage of the Republics weakened state after the Sith War. The tactical genius of Revan led these vessels to success after success, allowing them to survive through to the resurgence of the Sith under Revan and Malak after they turned to the Dark Side of the Force. While many of the crews defected to the Sith cause along with Malak and Revan, the vessels weren't taken in any great quantities due to the creation of destroyers copied from the defected Leviathan by the alien artifact the Star Forge. This left these excellent, but less advanced vessels fighting an ever increasing tide of Leviathan Class Destroyers, something which led to most examples of this class being destroyed in combat, although a few survived through until the Imperial Era when the design was somewhat revised and updated by the C.E.C.

FRIGATES



Addendum Personal- General Han Solo

Nearly a hundred thousand years ago this ship was a thing to be feared and respected. Now it couldn't and wouldn't hold a glow rod to an Imperial Star Destroyer...

GARMAN CLASS GAS MINER

Craft: Corellian Engineering Garman-class Gas Miner

Type: Atmospheric mining vessel

Era: Rise of the Empire

Affiliation: General

Source: Flashpoint! Brak Sector (pages 28-29)

Scale: Capital

Length: 300 meters

Skill: Space transports: Garman mining vessel

Crew: 300, gunners: 4, skeleton: 150/+5

Crew Skill: Capital ship shields 3D+2, mining: atmospheric mining 4D, sensors 3D, space transports 3D, starship gunnery 2D+1

Passengers: 20

Cargo Capacity: 70,000 metric tons

Consumables: 2 years

Cost: 7.5 million credits(new), 5.8 credits million (used)

Hyperdrive Multiplier: x2

Hyperdrive Backup: x8

Nav Computer: Yes

Space: 4

Atmosphere: 280; 800 kmh

Hull: 3D

Shields: 2D

Sensors:

Passive: 3 (3 km)/1D

Scan: 6 (6 km)/1D+2

Search: 10 (10 km)/2D

Focus: 1 (1 km)/3D

Weapons:

4 Quad Laser Cannons

Fire Arc: 1 front, 1 left, 1 right, 1 back

Crew: 1

Scale: Starfighter

Skill: Starship gunnery

Fire Control: 2D

Space Range: 1-5/10/15

Atmosphere Range: 100-500/10/15 km

Damage: 2D+2

Carried Craft: 20 Atmospheric Gas Skimmers

Capsule: Designed and manufactured by the Corellian Engineering Corporation, the *Garman*-class mining vessel was a 300-meter-long starship was developed to serve as the base for a small fleet of Gas Skimmer GS-IIIs. Each *Garman*-class ship could transport up to twenty skimmers, and had a series of collection tanks which were used to store the gases collected by the skimmers from gas giant planets. These ships required a crew of 300 officers and four gunners, and could transport up to twenty passengers and 70,000 metric tons of cargo. To protect themselves from pirates, the *Garman*-class ships were armed with four quad laser cannons.

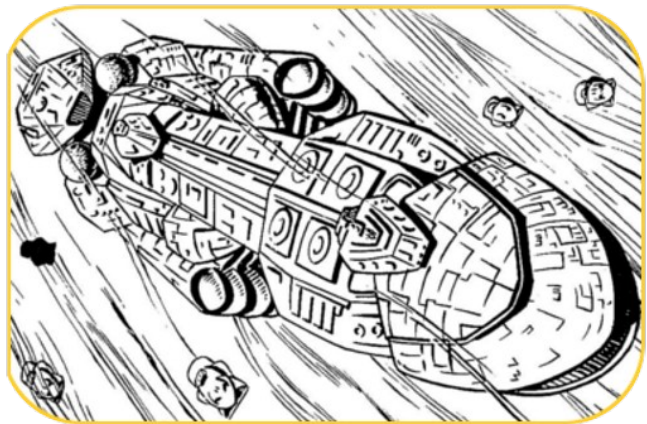

Addendum Personal- General Han Solo

Lando had a fleet of these things working around Cloud City. He said they were functional, if not slow. He compared their speed and reaction time to that of a drunk Tusken Raider...

GRECKON CLASS FRIGATE

Craft: Corellian Engineering Corporation's Greckon-class Frigate

Type: Archaic frigate

Era: Old Republic

Affiliation: General, Galactic Republic

Source: Ryan Matheny (rpggamer.org)

Scale: Capital

Length: 380 meters

Crew: 870 Gunners: 34

Cargo Capacity: 1,200 metric tons

Cost: Not available for sale

Nav Computer: Yes

Hyperdrive Multiplier: x8

Hyperdrive Backup: x24

Maneuverability: 1D

Space: 3

Atmosphere: 260;750

Hull: 2D+1

Shields: 1D+1

Sensors:

Passive: 25/0D

Scan: 50/0D+2

Search: 75/1D

Focus: 7/1D+2

Weapons:

Fusion Torpedo Tube

Fire Arc: Front

Crew: 10

Scale: Capital

Skill: Archaic starship weapons

Ammo: 8

Fire Control: +2

Fire Rate: 1/3

Space Range: 1-3/12/25

Ammo: 30 torpedoes

Damage: 4D+1

3 Laser Cannon Batteries

Fire Arc: 1 left, 1 right, 1 turret

Crew: 8

Scale: Starfighter

Skill: Archaic starship weapons

Fire Control: 1D

Space Range: 2-5/10/16

Damage: 3D

Capsule: The Greckon-class Frigate was the mainstay of the Old Republic and many independent fleets for almost a century during the time of the Old Republic. The vessels were mass produced to fill the gaps between fighters, shuttles and the huge battlecruisers of the time. Although not capable of directly fighting a cruiser on its own, in groups it is quite capable of laying waste to larger ships. Against fighters the ships are vulnerable, due to the fact that designers failed to place light blaster cannons or particle beams on the ships. Thus most frigates are supported by a flight of Z-95 fighters for protection. A large number of these ships still exist, but primarily on the outer fringe systems.



Addendum Personal- General Han Solo

The Greckon write-up makes it sound as though the design was the one of toughest around, ready to go toe-to-toe with any force it met. Yet the hull plating and shield ratings for a 'stock' YT-1300 are better by far. I've never seen one in battle, but I did see one plow into the side of a mountain though. Let's say the mountain was unimpressed...

KLEEQUE CLASS

INTER-SYSTEM FERRY

Craft: Corellian Engineering Corporation's *Kleeque*-Class

Type: Modified Inter-System Ferry

Era: Rebellion, New Republic

Affiliation: General

Source: crmcneill

Scale: Capital Ship

Length: 250 meters

Skill: Space Transports: *Kleeque*-Class

Crew: 16 (4 @ +10) & 2 Gunners

Crew Skill: Astrogation 4D, Gunnery 4D, Piloting 4D, Shields 3D+2, Sensors 3D+1

Passengers: 1,000

Cargo Capacity: 200,000 metric tons

Consumables: 1 month

Cost: 350,000 credits new, 175,000 used

Hyperdrive Multiplier: x2

Hyperdrive Backup: x10

Nav Computer: Yes

Maneuverability: 1D

Space: 4

Atmosphere: 480; 800 kph

Hull: 3D

Shields: 1D

Sensors:

Passive: 20/0D

Scan: 40/1D

Search: 60/2D

Focus: 3/2D+2

Weapons:

2 Dual Laser Cannon

Fire Arc: 1 Turret (Ventral), 1

Rear/Left/Right

Crew: 1

Scale: Starfighter

Skill: Starship Gunnery

Fire Control: 2D

Space Range: 1-3/12/25

Atmosphere Range: 100-300/1.2/2.5km

Damage: 5D

Capsule: The *Kleeque*-Class began service as an inter-system ferry, transporting passengers and ground vehicles between nearby systems. Featuring four boarding ramps (two each forward and aft) as well as port and starboard docking rings and a sliding dorsal hatch for landing airspeeders, the *Kleeque* could carry 1,000 passengers and their personal vehicles in relative comfort. Its passenger areas (located in the upper decks above the vehicle bays) are a mix of basic acceleration couches, dormitory-style bunks and small cabins. In atmosphere, the ship's powerful engines were augmented by an array of port and starboard auxiliary repulsorlift thruster units, which provided the ship with both additional thrust when carrying heavy loads and improved maneuverability when landing and taking off in tight quarters.

While intended for civilian use only, modified versions of the *Kleeque* have also entered service as troop transports, as the ship's facilities are perfectly suited to transporting an armored battalion, or serving as a general military transport. The Alliance commonly use *Kleeque*-class ships to move units between operational theaters, as the ship is not intended to enter space combat. Despite this, the ships are occasionally used to run blockades or as landing craft into hot landing zones. Alliance space, personnel and equipment pressures being what they are, *Kleeques* tend to be overcrowded, overworked and under crewed.

FRIGATES

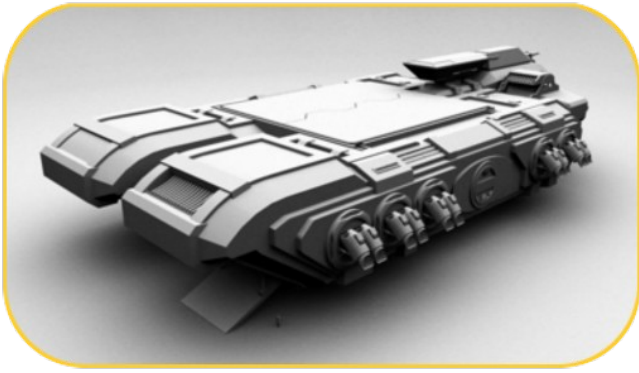

Addendum Personal- General Han Solo

When they aren't being used to transport military personnel from one theater to another, they can be seen in use by civilians everywhere. They function just like they were designed, inter-sector travel - small planetary or even system to system jumps...

STARBOLT CLASS

ASSAULT CARRIER

Craft: Corellian Engineering Corporation
Starbolt-class Assault Carrier

Type: Assault Carrier

Era: Rebellion

Affiliation: Alliance to Restore the Republic,
General

Source: Dark Covenant (p.70), wookieepedia,
stats by +Oliver Queen

Length: 385 meters

Scale: Capital

Skill: Capital ship piloting: *Starbolt*-class

Crew: 800, gunners: 16, skeleton: 15/+10

Passengers: 250

Cargo Capacity: 300 metric tons

Consumables: 2 years

Cost: 10 million (does not include price of
starfighters and airspeeders)

Hyperdrive Multiplier: x2

Hyperdrive Backup: x10

Nav Computer: Yes

Maneuverability: 2D

Space: 6

Hull: 3D

Shields: 3D

Sensors:

Passive: 20/0D

Scan: 40/0D

Search: 80/1D

Focus: 2/2D

Weapons:

2 Heavy turbolasers

Fire Arc: Turret

Crew: 3

Scale: Capital

Skill: Capital ship gunnery

Fire Control: 2D

Space Range: 3-15/35/75

Atmosphere Range: 6-30/70/150 km

Damage: 7D

4 Light Turbolasers

Fire Arc: Turret (2 left), (2 right)

Crew: 1

Scale: Capital

Skill: Capital ship gunnery

Fire Control: 3D

Space Range: 3-15/35/75

Atmosphere Range: 6-30/70/150 km

Damage: 4D

2 Heavy Ion Cannons

Fire Arc: Turret

Crew: 2

Scale: Capital

Skill: Capital ship gunnery

Fire Control: 4D

Space Range: 1-10/25/50

Atmosphere Range: 2-50/50/100 km

Damage: 5D

Twin proton torpedo launcher (fire-linked)

Fire Arc: Front

Crew: 1

Scale: Capital

Skill: Capital ship gunnery

Fire Control: 3D

Space Range: 1/3/7

Atmosphere Range: 50-100/300/700

Ammo: 8 salvos

Damage: 10D

Heavy tractor beam

Fire Arc: Front

Crew: 1

Scale: Capital

Skill: Capital ship gunnery

Fire Control: 2D

Space Range: 1-5/10/17

Atmosphere Range: 100-500/1/1.7 km

Damage: 4D

Starship Complement: 24 starfighters, 2 shuttles.

Vehicle Complement: 6 assault speeders, 4 troop

FRIGATES

speeders, 2 command speeders

Capsule: Corellian Engineering Corporation's Starbolt assault carrier was sold as an integrated ship and weapons system, complete with its own starfighter squadron, airspeeders and a command speeder. The ship entered the market a few years before the Clone Wars and was sold to mercenary units, planetary defense forces and similar units throughout the war. With the establishment of the Empire, C.E.C. lost out to KDY and Siemar Fleet Systems for major Imperial contracts. The Starbolt was eventually discontinued partly due to reduced sales, but mainly due to Imperial edicts limiting the sale of military-grade systems to non-governmental and non-Imperial entities.

Starbolts remaining in service rarely have their original complement of speeders and fighters. Most have long been replaced with more modern, better-suited, or more readily available craft. However, the ship is still an effective assault craft, and one that many star systems still employ on a regular basis in their ongoing battles with pirates and Rebels. Worn out or damaged Starbolts have been salvaged by mercenary units and the occasional pirate as well.

While the Starbolt was an easy-to-purchase package system and a competent assault craft, its on-board vessels were not themselves designed specifically for the ship. Rather, C.E.C. partnered with other manufacturers to provide an excellent deal as well as an optimized combat solution for its buyers. Speeders were always sourced from other producers, as they were not part of C.E.C.'s product line. While C.E.C. promoted their own starfighters in a package deal, most buyers opted for other craft. The most common configuration carried a squadron of Y-wings with a package of Mekuun vehicles—Invader assault speeders, Rush transport speeders and Overwatch Command Speeders.



Addendum Personal- General Han Solo

These things are like a mini-Star Destroyer, complete with starfighters and enough firepower to make you wish you were never pulled from your mother's womb...

CHAPTER 15

CRUISERS

First off I want to thank Han Solo for once more offering me this writing gig, it will go a long way towards paying off some of my medical bills after that run in with Kyle Katarn over Jan Ors.

Next let me publicly, and in print, apologize for my earlier comments as to the nature of my relationship with Jan. Y'see, Jan and I know one another from our mutual acquaintance Kyle Katarn and my comments about the nature of any relationship that Jan and I had are and continue to be untrue. I hope that she accepts this humble apology and sees her way to forgiving me for the comments I made and that Kyle Katarn doesn't come back for round two of the beating that he dished out to me after saying what I said...

Having gotten that out of the way, let me talk a little bit about the Corellian Engineering Corporation's cruiser-class vessels since after all that's what I am getting paid to do. The cruiser designation for warships is seconded only to battleships and was to a certain extent used by the Trade Federation, the Confederacy of Independent Systems and the Imperials as well. In some of the classification systems the cruiser is divided into three categories: light, medium and heavy, ranging in size from three hundred and fifty meters at the smallest light to six hundred plus meters being the largest. Although truthfully the Corellian Engineering Corporation doesn't seem to recognize the classification system adapted from the Galactic Imperial Measurement Project and for that matter neither does ol' Rik Duel because I don't want anything to do with the Imperials and their Galactic Imperial Measurement Project either.

My personal experience with cruisers comes from having been chased by them on more than one occasion and being taken aboard one as a prisoner. These things are huge, with plenty of armor to protect them and more weapons than you can ever possibly hope to escape from. This is my quote about cruisers, chosen from an admiral that fought during the Galactic Civil War...

“Cruisers are designed to take the brunt of the attack and dish out as much damage as possible. They will transport troops, run interference and inflict hell on those foolish enough to attack. As my Simpi' back on Sumara used to say ‘Always be prepared for your enemy. If he has superior strength, avoid him. If he is volatile,

seek to enrage him. Feign weakness, so that he will grow arrogant. If he is relaxed, give him no chance to be at rest. If his soldiers are united, then separate them. Attack him when he least expects it, and appear where you are not expected to be.’”

**Obi-Jobe Owens
Sumari Admiral assigned to the Mutt Squad**

**Rik Duel
‘Free trader’ and proud owner of ‘The Moonshadow’**

STARFIRE CLASS BATTLECRUISER

Model: Corellian Engineering Corporation's Starfire-class Battlecruiser

Type: Heavy battlecruiser

Era: Old Republic (900 BBY)

Affiliation: Galactic Republic

Source: Ryan Matheny (rpggamer.org)

Scale: Capital

Length: 498 meters

Skill: Capital ship piloting: Starfire battlecruiser

Crew: 8,152; gunners: 117; Skeleton: 829/+15

Crew Skill: Astrogation 3D+2, capital ship gunnery 4D, capital ship piloting 4D

Passengers: 200 (troops)

Cargo Capacity: 13,600 metric tons

Consumables: 2 years

Cost: Not available for sale

Hyperdrive Multiplier: x4

Hyperdrive Backup: x28

Nav Computer: Yes

Maneuverability: 1D

Space: 5

Hull: 4D+2

Shields: 1D+2

Sensors:

Passive: 30/0D

Scan: 55/1D

Search: 120/2D

Focus: 4/3D

Weapons:

12 Turbolaser Cannons

Fire Arc: 2 front, 5 left, 5 right

Crew: 2

Scale: Capital

Skill: Capital ship gunnery

Fire Control: 2D+1

Space Range: 3-15/35/75

Damage: 2D

15 Quad Turbolaser Cannons

Fire Arc: 5 front, 5 left, 5 right

Crew: 3

Scale: Capital

Skill: Capital ship gunnery

Fire Control: 2D

Space Range: 3-20/40/80

Damage: 4D

10 Turbolaser Batteries

Fire Arc: 5 left, 5 right

Crew: 3

Skill: Capital ship gunnery

Fire Control: 1D

Space Range: 3-10/30/60

Damage: 7D

6 Concussion Missile Launchers

Fire Arc: 1 front, 2 left, 2 right, 1 back

Crew: 3

Scale: Starfighter

Skill: Capital ship gunnery

Fire Control: 1D

Space Range: 5-13/20/45

Atmosphere Range: 500-1.3/2/4.5 km

Ammo: 20 missiles each

Damage: 6D

Capsule: The Corellian Starfire once served the Republic with dignity for over a century until its eventual decommission. It was the pride of the fleet, wielding an impressive array of weaponry designed to be implemented against any space-bound enemy. A combination of turbolaser cannons and batteries for both ship-to-ship combat and planetary bombardment combined with six anti-starfighter concussion missile batteries made the Starfire so successful that it didn't take long before the Republic had them deployed to every sector of controlled space. Massive Corellian ion drives and maneuvering thrusters made the Starfire one of the more agile starships of its size. The Class Four hyperdrive was standard of the era in which it was designed, allowing it to conduct interstellar travel in what was once considered optimal time.

CRUISERS

Extensive shielding and reinforced hull armor gave the vessel an uncanny ability to absorb impressive amounts of fire with only minimal to moderate damage. It wasn't an uncommon sight for a Starfire to continue fighting even with extensive damage to what was widely considered critical areas. The Starfires were slowly brought out of service more than a century following their debut as the Republic moved toward its next generation of warships. Some were sold off while the majority of the Starfires were scrapped or converted into troop and cargo transports.

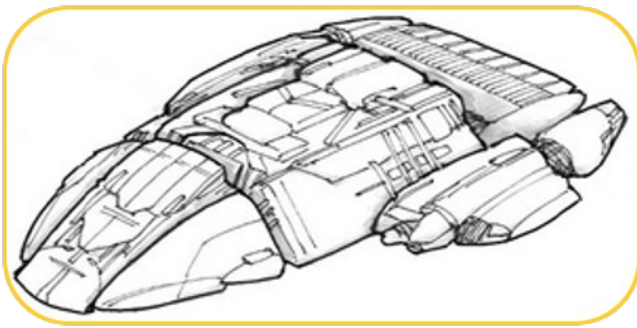

Addendum Personal- General Han Solo

This is the only time I've ever seen a 'Starfire' and the I can't help but think that for a society that 'hadn't had a standing army for almost a thousand years', the Republic sure did have a lot of warships...

CHAPTER 16

HEAVY CRUISERS

Well, ‘Princess’ Solo is at it again.

The last time I wrote one of these introductions it was for two ships that I knew nothing about and I got a measly five hundred credits for all my hard work and then to make matters worse, Solo sends some Corellian Engineering Corporation litigators around to threaten me over my supposed ‘litigious’ comments from the book.

Well you see who is still out of jail and never been sued by the Corellian Engineering Corporation, that’s right...ME!

I guess we can all see who *really* wears the pants in that family and the nepotism continues in this book too. His buddy Lando Calrissian gets a chapter and his pet Wookiee gets one about frigates. Hell, some half-breed Corellian kid even got one and I’ve never heard of him! I’m surprised that his ‘Jedi’ brother-in-law didn’t get a chapter about the starfighters or talking about ‘having a bad feeling’ or ‘disturbances in the force’. Yeah, I got their ‘disturbance in the Force’... Y’see kids, this is what happens you tell the truth and try to make things right. Not only does no one listen to you, but you get threats and a pay cut.

That’s right, now I’m only getting two hundred and fifty credits for writing this introduction, if I had known it was two hundred and fifty credits per ship to write an introduction I would have wanted the chapter on ‘corvettes’ instead of the them sticking me with this pile of poodoo...So since I am writer and you have to read everything I say, now the truth is really coming out.

Y’see, when it comes to Princess Leia, Han Solo is a second choice...

Oh, that’s right. Y’see when I was ‘helping her search for Han...’, and funny that she had to search for him since everyone knows that Jabba lives on Tatooine in his palace and routinely keeps his prisoners there with him if not for any other reason than to feed them to his pet rancor and yet the princess came to *me* for help and during the search we became quite *close*...I ain’t the type to kiss and tell, but if Calrissian hadn’t ‘suddenly’ located Han on Tatooine, and I didn’t have to let the princess down easy like, then it might have been me hobnobbing with the rich and famously wealthy of New Alderaan and getting the lucrative writing

deals...

Getting back on topic, like Solo said the *Proficient*-class cruiser is a ‘**recommissioned battle cruiser from the early days of the Republic**’. There’s my introduction and quote, I’m off to collect my two hundred and fifty credits!

Dash Rendar
Proud owner of the Outrider and Outrunner

PROFICIENT CLASS BATTLECRUISER

Craft: Corellian Engineering Corporation

Proficient-class cruiser

Type: Light cruiser

Era: New Republic (recommissioned ~20 ABBY)

Affiliation: New Republic

Source: wookieepedia, +stats by +Oliver Queen

Scale: Capital

Length: 850 meters

Skill: Capital ship piloting: *Proficient-class cruiser*

Crew: 1,240, gunners ; skeleton: /+15

Cargo Capacity: 5,000 metric tons

Consumables: 2 years

Cost: Not available for sale

Hyperdrive Multiplier: x1

Hyperdrive Backup: x10

Nav Computer: Yes

Maneuverability: 2D

Space: 6

Hull: 5D

Shields: 2D

Sensors:

Passive: 50/2D+1

Scan: 100/3D+1

Search: 200/4D+1

Focus: 6/5D

Weapons:

10 Turbolasers

Fire Arc: 4 front, 2 left, 2 right, 2 rear

Crew: 3

Scale: Capital

Skill: Capital ship gunnery

Fire Control: 3D

Space Range: 3-15/35/75

Atmosphere Range: 6-30/70/150 km

Damage: 7D

20 Ion Cannons

Fire Arc: 10 front, 5 left, 5 right

Crew: 1

Scale: Capital

Skill: Capital ship gunnery

Fire Control: 2D

Space Range: 1-10/25/50

Atmosphere Range: 2-20/50/100 km

Damage: 4D

Capsule: The *Proficient-class* cruiser was a Corellian warship produced in the early decades of the New Republic. The *Proficient-class* was found across New Republic battle groups until the New Class Project standardized the vessels across the Fleet. During the Yuuzhan Vong War, however, the starship-strapped New Republic reactivated a number of *Proficient-class* cruisers. The cruiser measures 850 meters in length and runs on a Damorian power plant. Weapon systems include ten heavy turbolasers and twenty ion cannons, a light armament for the cruiser's size. Much of the ship's interior is occupied by modular compartments, but most vessels sacrificed those for docking bay facilities.



Addendum Personal- General Han Solo

This is a recommissioned battle cruiser from the early days of the Republic. I've never seen the original, just the re-make and while it seems to live up to expectations I can't help but wonder if they really bothered to improve much other than the hyperdrive speed...

CHAPTER 17

STAR DEFENDERS

I was asked to write an introduction for the chapter about ‘Star Defenders’. What I know about them amounts to this, my father is the only person that I know who owns his own Star Destroyer, take that in for a second and think about what I just said.

He *owns* a Star-Destroyer.

I could regale you with the story about how he was part of the attack force that bluffed the then captain of the Star Destroyer into believing that he had banks and banks of proton torpedoes aimed at his ship, but my father tells the story better and if you get a few drinks into him he will stand up on the nearest table and tell the story in a very animated fashion using his one free hand to act out the dog fights that went on around the Star Destroyer that day.

My father loves telling that story and will do so to anyone who cares to hear the tale. Personally I’ve seen enough war and death in my lifetime that I’ve begun to think that maybe that’s all I’ve ever seen. I remember a quote that was attributed to a Jedi Master; I can’t remember his or her name, just the quote:

“There is no great victory in war, because wars don’t make people great.”

With everything that I have seen, I can’t help but think that who ever said that knew more than I ever would about life, the universe and everything else. Getting back to the original topic, my father took the Star Destroyer and for a princely sum sold most of the weapons back to the New Republic and turned it into a casino and port of call for free-traders, freighter captains and people of a less moral attitude when it came to certain restrictive shipping laws.

He didn’t go out and become a pirate because despite what CorSec will tell you about Booster Terrik, that isn’t who he is. He wanted a place that he could make money from and where he could drink and talk to his friends, a place that could carry him into his old age and provide for his family when he one day leaves this universe for whatever waits for us in the place beyond all of this.

A Corellian Jedi once said that **‘if you strive for peace, you should prepare for war.’** I think he was wrong. Maybe we should stop preparing for war and try to find the peace that

eludes us all, find a new way to start living, and if there is a chance, add to the population of the universe by having a few more babies...maybe we should have some.

Big fat, roly-polly sorts of babies who smile a lot.

That’s my half a credits worth of thought about Star Defenders...

Mirax Terrik Horn
Proud Corellian free-trader and smuggler of goods...

STRIDENT CLASS STAR DEFENDER

Craft: Corellian Engineering Corporation
Strident-class Star Defender

Type: Star Cruiser

Era: New Republic

Affiliation: New Republic

Source: Homemade-Stats contributed by
RPGgamer.org

Scale: Capital

Length: 6,250 meters

Skill: CS piloting: Mon Cal cruiser

Crew: 68,124; gunners: 4,910; skeleton:
12,660/+10

Crew Skill: Astrogation 4D(2), CS gunnery
5D+2(2), CS piloting 6D+1(2), CS shields
5D+2(2), sensors 4D(2)

Passengers: 12,000 (troops)

Cargo Capacity: 350,000 metric tons

Consumables: 6 years

Cost: Not publically for sale

Hyperdrive Multiplier: x1

Hyperdrive Backup: x10

Nav Computer: Yes

Maneuverability: 0D

Space: 5

Hull: 8D

Shields: 6D (3)

Sensors:

Passive: 75/1D+2

Scan: 150/3D+2

Search: 300/5D

Focus: 8/6D+2

Weapons:

500 Turbolaser Batteries

Fire Arc: 200 front, 120 left, 120 right, 60

rear

Crew: 2 (250), 3 (250)

Scale: Capital

Skill: Capital ship gunnery

Fire Control: 2D

Space Range: 3-15/35/75

Atmosphere Range: 6-30/70/150 km

Damage: 6D

500 Heavy Turbolaser Batteries

Fire Arc: 240 front, 100 left, 100 right, 60
rear

Crew: 2 (200), 3 (300)

Scale: Capital

Skill: Capital ship gunnery

Fire Control: 2D

Space Range: 3-15/35/75

Atmosphere Range: 6-30/70/150 km

Damage: 9D

500 Ion Cannon Batteries

Fire Arc: 200 front, 120 left, 120 right, 60
rear

Crew: 4 (400), 5 (100)

Scale: Capital

Skill: Capital ship gunnery

Fire Control: 4D

Space Range: 1-10/25/50

Atmosphere Range: 2-20/50/100 km

Damage: 6D (ionization)

130 Tractor Beam Projectors

Fire Arc: 60 front, 35 left, 35 right, 45 rear

Crew: 2

Skill: Capital ship gunnery

Fire Control: 4D

Space Range: 1-5/15/30

Atmosphere Range: 2-10/15/30 km

Damage: 9D

Carried Craft:

120 (3 wings, 1 squadron) T-65A3 X-wings

72 (2 wings) A-wings

72 (2 wings) E-wings

36 (1 wing) B-wings

12 (1 squadron) K-wings

14 (1 squadron, 1 element) T-65XJ X-

STAR DEFENDERS

wings
12 Lambda-class shuttles
10 Troop transports

Notes: The dual designation for the Star Defender is due to the new construction partnership between the Corellian Engineering Corporation and the shipyards of the Mon Calamari. The *Viscount*-class is built at Calamari, the *Strident*-class at Corellia. All other specifications are identical.

Mon Cal Star Defenders are configured to provide Mon Calamari with their +1D bonus for being in moist environments. These skill levels do not reflect these bonuses.

Mon Cal Star Cruisers have 6D of backup shields, When a die of shields is lost, if the shield operators can make an Easy *Starship Shields* check, one of the backup die codes of shields can be brought up to increase the shields back to 6D.

Capsule: Though it was built by a combined CEC/Mon Calamari effort, you wouldn't know it by looking at the ship. Like most other Mon Cal cruisers, the *Viscount/Strident*-class Star Defender is very organic and flowing, but has the quality of engineering CEC is known for. The Star Defender is over 6 kilometers long, and carries firepower to match. Though it has not yet taken on a Yuuzhan Vong ship, it would undoubtedly give a command cruiser a run for its money.

Addendum Personal- General Han Solo

Yeah, the New Republic finally got their own Star Destroyers. Having been chased by the Imperial version, consider me less than impressed. My brother-in-law is always quoting someone I've never met when he says 'Wars don't make people great...'



CHAPTER 18

MISCELLANEOUS SHIPS

So my good buddy Han Solo asked me to write a chapter introduction for his second Corellian Engineering Corporation book and here I am fulfilling my obligation. Most people know me as a gambler, smuggler and roguish scoundrel, what a lot of people don't know or may not remember is that I ran a starship sales yard for years on Corellia before I took on the position of Baron Administrator on Beshin's Cloud City for the Nklon Mining Corporation.

just do what you can to survive and eventually things will get better.

Lando Calrissian
Smuggler, Gambler and Galactic Entrepreneur

Starships are the lifeblood of any Corellian pilot and having been born on Socorro in the years before the Clone Wars, I can tell you that it doesn't matter what part of the Corellian system you come from, once a Corellian falls in love with a ship then they'll move heaven and Coruscant to get what they want.

Just ask Han Solo about *how* he won the Falcon. He outmaneuvered me at Sabacc and took the best ship off of my lot, where the Falcon was being repaired at the time. But the truth is that she is better taken care of than I could ever have done. You see, to an entrepreneur like me, ships come and go just like the credits in a high-stakes game of Sabacc. I have won and lost just as many over the years and while there are some that I purposefully divested from myself, there are others that I would gladly take back in a Coruscant moment...

Now since my chapter has to do with a myriad of ships and since there isn't a specific focus to the chapter I decided that I would talk a little bit about how important it is to learn to deal with the loss of a prized possession. My father instilled in me some wisdom and I thought that I would pass it along to you the reader without having to sit through a lecture about ethics as well, something that my father was apt to do whenever I got into trouble as a young man...

“Life often times is like a high-stakes game of Sabacc. Sometimes you're up three hundred thousand credits, got a beautiful woman at your side and no one can take that feeling away from you and then sometimes you've lost everything that you own and the Svapers have left you beaten and naked at the side of the road on some back-water planet in the middle of nowhere. But what matters most of all is that life, and the game, goes on no matter what side of the street you happen to come out on...”

Caldrone B. Calrissian

And there you have it my friend. If life throws you a curve

CL-1C

LANCET INTERCEPTOR

Craft: Corellian Engineering Corporation CL-1C Lancer Interceptor

Type: Starfighter

Era: Rise of the Empire

Affiliation: General, Alliance to Restore the Republic, Galactic Empire

Source: Suns of Fortune (p.108), stats by +Oliver Queen

Scale: Starfighter

Length: 12 meters

Skill: Starfighter piloting: CL-1C Interceptor

Crew: 1 (pilot)

Passengers: 1

Crew Skill: Varies widely

Cargo Capacity: 65 kilograms

Consumables: 2 days

Cost: 60,000 credits

Hyperdrive Multiplier: x1

Hyperdrive Backup: No

Nav Computer: Yes

Maneuverability: 3D+2

Space: 10

Atmosphere: 415; 1,200 kmh

Hull: 2D

Shields: 1D

Sensors:

Passive: 15/0D

Scan: 25/1D

Search: 50/1D+2

Focus: 2/2D

Weapons:

2 Medium Laser Cannons (fire-linked)

Fire Arc: Front

Crew: 1 (pilot)

Scale: Starfighter

Skill: Starship gunnery

Fire Control: 2D

Space Range: 1/3/7

Atmosphere Range: 50-100/300/700

Damage: 5D+1

Capsule: Sleek, fast, and agile, CL-1C Lancer fighters are designed to intercept and destroy enemy starfighters. A wingless, dart-shaped craft with a prominent vertical maneuvering fin, the Lancer has a powerful Cirodyne Ter22 high-output ion engine that provides exceptional speed and acceleration, allowing it to overtake most other starcraft. Used extensively by the Judicial Department during the days of the Old Republic, the Lancer is still employed by the Corellian defense and CorSec forces.



Addendum Personal- General Han Solo

I ain't much for starfighters. They've never really been my thing. The lancer is quick and has a decent weapons system, but has the hull rating of a TIE Fighter. If you want a decent snub fighter, see if you can find a Z-95 Headhunter instead...

CORELLIAN HEAVY LIFTER

Model: Corellian Engineering Corporation Heavy Cargo Lifter

Type: Cargo Lifter

Era: Old Republic, Rise of the Empire, Rebellion

Affiliation: General

Source: RPGamer.org

Scale: Starfighter

Length: 90 Meters

Skill: Starship Piloting: Heavy Lifter

Crew: 10; Skeleton: 3/+15

Crew Skill: Astrogation 4D+1, Starship Piloting 5D+2, Starship Shields 4D+1, Starship Gunnery 5D+2, Sensors 5D

Passengers: 20

Cargo Capacity: 500 tons (an additional external cargo pod can carry 5,000 tons)

Consumables: 6 Months

Cost: 1 Million credits (new), 300,000 credits (used) (50,000 per external cargo pod)

Hyperdrive Multiplier: x3

Hyperdrive Backup: x15

Nav Computer: Yes

Maneuverability: 1D

Space: 6

Atmosphere: 330, 950 kmh

Hull: 4D

Shields: 2D

Sensors:

Passive: 30/1D

Scan: 60/2D

Search: 90/3D

Focus: 3/4D

Weapons:

Tractor Beam Projector

Fire Arc: Front

Crew: 1

Scale: Starfighter

Fire Control: 2D

Space Range: 1-2/6/12

Atmosphere: 1/12/24 km

Damage: 4D

Capsule: The Heavy Lifter was originally conceived as a cargo vessel, with a small internal cargo hold, but the capability of carrying larger cargo pods externally. With the capability of landing on a planetary surface the Heavy Lifter can drop a cargo pod off, and lift back into space without tying up the starship until the cargo can be unloaded, this was seen as a bonus in busy starports. However in practicality, the cost of the cargo pods, combined with the fact that the pod was still tying up a starport until another lifter could move it, with starport facilities being more in demand than starships, led to the ship not selling particularly well. However the Heavy Lifter capabilities for transporting cargo has led to its massive success in other areas, such as salvage where the Lifter can dock with other ships and easily carry them through hyperspace with it. The Rebellion used Heavy Lifters to transfer vehicles onto the battlefield, dropping them off using its powerful tractor beams and allowing Rebel forces the same flexibility as dropships allowed the Empire.



Addendum Personal- General Han Solo

I've seen a similarly shaped capital ship that was used as a transport vessel for fighters during the Clone Wars. I heard rumor that there were a dozen or so of the ships produced by CEC and that the Heavy Lifter was visually based off of the capital ship...

CORELLIAN SCOUT

Model: Corellian Engineering Corporation's Scout

Type: Scout

Era: Old Republic (300 BBY)

Affiliation: General, Galactic Republic

Source: Ryan Matheny (rpggamer.org)

Scale: Capital

Length: 114 meters

Skill: Capital ship piloting: Corellian scout

Crew: 12; skeleton: 2/+15

Crew Skill: Astrogation 4D, capital ship piloting 4D, sensors 4D

Passengers: 4

Cargo Capacity: 1,000 metric tons

Consumables: 1 year

Cost: Not available for sale

Hyperdrive Multiplier: x4.3

Hyperdrive Backup: x18

Nav Computer: Yes

Maneuverability: 1D

Space: 6

Atmosphere: 330; 950 kmh

Hull: 3D

Shields: 1D

Sensors:

Passive: 45/1D

Scan: 75/2D

Search: 160/3D

Focus: 5/3D+2

Capsule: The Corellian Scout served as the Old Republic's standard reconnaissance and scout vessel for many centuries. Like many Corellian starships, the Scout was a fine example of Corellian engineering and quality. In design, the scout was perhaps the earliest precursor to some later and well known designs - namely the star cruiser (Republic Cruiser), corvette and gunship - sporting many similar design aspects.

In appearance, the scout closely resembles the Corel-

lian Support Frigate which would make its debut many centuries later. Two massive ion drives propelled the vessel through the blackness of space while a wide array of communications transmitters and receivers were placed along various points of the hull. Later ships such as the Corvette would require only a single transmitter/receiver as the Empire standardized communication throughout the galaxy - something the Republic never did. The scouts were used very frequently, often being sent to investigate the validity of rumors for Fleet Command to prevent the mobilization of forces when the situation really does not require such. Other common uses for the scout included everything from ambassadorial transport to the mapping of unexplored space.

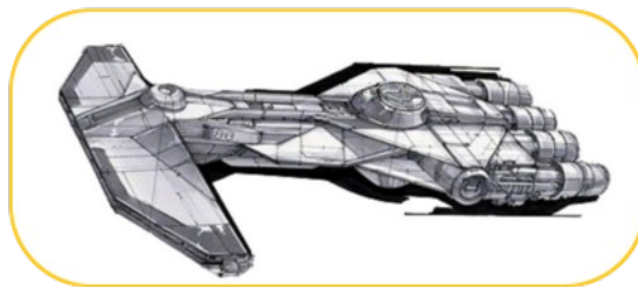

Addendum Personal- General Han Solo

I've never been aboard one, but during the Galactic Civil War the Alliance used several of these for general transport...

CR-20

REPUBLIC CARRIER

Craft: Corellian Engineering Corp. CR-20 Light Cruiser

Type: Troop carrier

Era: Rise of the Empire

Affiliation: General, Old Republic

Source: Keith Kilburn

Scale: Capital

Length: 60 meters

Skill: Capital ship piloting: Republic Carrier

Crew: 6 (pilot, co-pilot, engineer), gunners 2; Skeleton 1/+5

Crew Skill: Astrogation 3D, capital ship piloting 4D+2, capital ship shields 3D+1, sensors 3D+2

Passengers: 40 (troops)

Cargo Capacity: 50 metric tons

Consumables: 2 months

Cost: Not Available for Sale (45,000 credits on invisible market)

Hyperdrive Multiplier: x2

Hyperdrive Backup: x15

Nav Computer: Yes

Maneuverability: 2D

Space: 5

Atmosphere: 450; 700 kmh

Hull: 3D+1

Shields: 2D+1

Sensors:

Passive: 25/1D+1

Scan: 50/2D

Search: 75/2D+2

Focus: 3/3D

Weapons:

2 Double Turbolaser Cannons

Fire Arc: Turret (left and right)

Crew: 1

Scale: Capital

Skill: Capital Ship Gunnery

Fire Control: 1D+2

Space Range: 1-8/17/60

Atmosphere Range: 100-800/1.7/6 km

Damage: 3D+2

Capsule: Originally designed by the Corellian Engineering Corporation for use by its security forces, the Republic purchased surplus CR-20s one standard month after the First Battle of Geonosis. Despite this, they were widely unseen in the Republic Navy early in the Clone Wars. It was not until the Battle of JanFathal, where Anakin Skywalker piloted a CIS-owned CR-20 to rescue Republic Intelligence operative Hallena Devis, that the usefulness of the CR-20 Troop Carrier became evident. Generally, they were used in situations where the large *Acclamator*-class assault ships were impractical or unneeded.



Addendum Personal- General Han Solo

During the war, the Rebellion used a small fleet of CR-20s to move troops around the outer rim. It went badly when they were ambushed. Twenty-five CR-20s burnt up under turbolaser fire in the Ashcraft Corridor near Gnola in the Duthor system...

CR-25

TROOP CARRIER

Craft: Corellian Engineering Corporation CR-25 Troop Carrier

Type: Troop carrier

Era: Rise of the Empire

Affiliation: Old Republic, General

Source: wookieepedia, stats by +Oliver Queen

Scale: Capital

Length: 60 meters

Skill: Capital ship piloting: CR-25

Crew: 8 (pilot, co-pilot/navigator, engineer, loadmaster), Gunners: 4; Skeleton 2/+8

Passengers: 40 (troops)

Cargo Capacity: 50 metric tons

Consumables: 2 months

Cost: Not Available for Sale

Hyperdrive Multiplier: x2

Hyperdrive Backup: x15

Nav Computer: Yes

Maneuverability: 1D+1

Space: 4

Atmosphere: 210; 600 kmh

Hull: 4D

Shields: 2D

Sensors:

Passive: 25/1D+1

Scan: 50/2D

Search: 75/2D+2

Focus: 3/3D

Weapons:

2 Double Turbolaser Cannons

Fire Arc: Turret (left and right)

Crew: 2

Scale: Capital

Skill: Capital Ship Gunnery

Fire Control: 1D+2

Space Range: 1-8/17/60

Atmosphere Range: 100-800/1.7/6 km

Damage: 3D+2

Complement: 2 LAAT/i gunships, 2 AT-PT, 12 74-Z speeder bikes

Capsule: The CR-25 troop carrier, more commonly known as the Republic dropship, was a multipurpose dropship used to deploy units of clone troopers and gunships in battlefronts where the use of an *Acclamator*-class assault ship was deemed too impractical. The Clone Commandos and Galactic Marines favored the CR-25 over the CR-20, because it had more cargo space, could hold two LAAT/i gunships, twelve 74-Z speeder bikes, four All-Terrain Personal Transports and had ports for null gravity space debarking. The CR-25 was known as the "bigger brother" of the CR-20 troop carrier. Delta Squad traveled in a CR-25 and used its debarking ports to board the captured assault ship *Prosecutor*.



Addendum Personal- General Han Solo

The first and last time I saw a CR-25, it was crewed by a pirate named Jyve Omahlsdahl, a member of a specialized Rebel cell. He stole one as he broke ties with the Rebellion. I'm told he rigged a half-dozen astromechs together to use as a crew. Somehow he secured his farking Ghtroc light freighter to the outer hull and made the jump to lightspeed. Alliance Intelligence never did find him and I made a promise that if I ever saw him again, I'd shoot him just on principle...

CRIX

ASSAULT SHUTTLE

Craft: Mon Calamari Shipyards/CEC *Crix*-Class
A-2s Armored Shuttle

Type: Armored assault shuttle

Era: Legacy

Affiliation: Galactic Alliance

Source: Wookieepedia; Stats by Keith Kilburn

Scale: Starfighter

Length: 43 meters

Skill: Starfighter piloting: *Crix* shuttle

Crew: 9 (pilot, co-pilot/navigator, engineer),
gunners: 6; Skeleton: 2/+8

Crew Skill: Astrogation 4D, starfighter piloting
4D+2, starship gunnery 5D, starship shields 4D

Passengers: 50

Cargo Capacity: 50 metric tons

Consumables: 1 month

Cost: 600,000 credits (new), 260,000 credits
(used)

Hyperdrive Multiplier: x1

Hyperdrive Backup: x10

Nav Computer: Yes

Maneuverability: 2D

Space: 5

Atmosphere: 395; 850 kmh

Hull: 6D+2

Shields: 3D+1*

Sensors:

Passive: 20/0D

Scan: 40/1D

Search: 60/2D

Focus: 3/3D

Weapons:

2 Twin Laser Cannons (fire-linked)

Fire Arc: Front

Crew: 1 (pilot or co-pilot)

Scale: Starfighter

Skill: Starship gunnery

Fire Control: 3D

Space Range: 1-3/12/25

Atmosphere Range: 100-300/1.2/2.5 km

Damage: 5D

6 Blaster Cannons

Fire Arc: 1 front, 2 right, 2 left, 1 back

Crew: 1

Scale: Starfighter

Skill: Starship gunnery

Fire Control: 3D (can be set to auto-fire,
using only the Fire Control dice)

Space Range: 1-3/12/25

Atmosphere Range: 100-300/1.2/2.5 km

Damage: 7D

Carried Craft: 2 landspeeders or 6 speeder bikes.

Game Notes: The *Crix* has 3D in backup shields. When a die of shields is lost, the shield operator can attempt to make an Easy *Starship Shields* roll. If successful, one of the backup shield dice can be activated to bring the shields to full capacity. Once all three backup dice are exhausted, the shields can withstand the normal amount of damage and then must be completely overhauled.

Capsule: The *Crix*-class displayed certain characteristics of both CEC designs as well as some Mon Calamari features, given their cooperation on the design. The hulls showed the Mon Cal influence, while the interior, bridge and engines were very Corellian.

It had an armored shell with a narrow slot between the two halves for the engines, cockpit and weapons. It also had a long, narrow fin mounted on the upper hull which contained powerful long-range communication arrays. The A-2s was heavily armed and shielded and possessed significant firepower. The area between the shells was ringed by a series of blaster cannons, that could be fired automatically or by troopers aboard the ship. It also included four boarding ramps for rapid deployment of troopers and speeders. An alternate variant of the vessel, the *Crix*-class Diplomatic Courier Shuttle or Dc-4a also existed, with lighter armor, firepower and shielding.

MISCELLANEOUS SHIPS

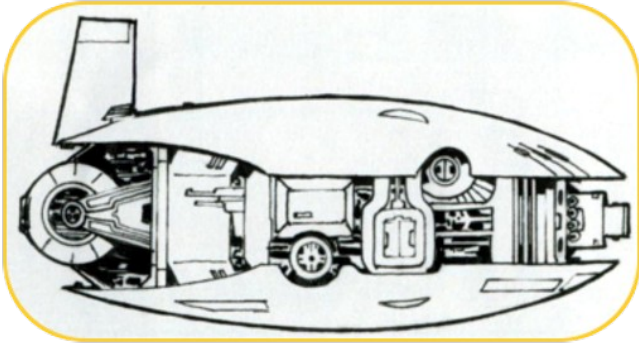

Addendum Personal- General Han Solo

As an aside, General Crix Madine was not pleased the ship was named after him. For that matter neither was his mother, or so I am told...

CRIX

DIPLOMATIC COURIER

Craft: Mon Calamari Shipyards/Corellian Engineering Corporation *Crix*-class DC-4a Armored Shuttle

Type: Armored diplomatic courier

Era: New Republic, Legacy

Affiliation: Galactic Alliance

Source: Legacy Era Campaign Sourcebook

Scale: Starfighter

Length: 43 meters

Skill: Starfighter piloting: Crix shuttle

Crew: 5, gunners: 2

Crew Skill: Astrogation 4D, starfighter piloting 4D+2, starship gunnery 5D, starship shields 4D

Passengers: 30

Cargo Capacity: 50 metric tons

Consumables: 2 months

Cost: 500,000 credits (new), 200,000 credits (used)

Hyperdrive Multiplier: x1

Hyperdrive Backup: x10

Nav Computer: Yes

Maneuverability: 2D

Space: 5

Atmosphere: 295; 850 kmh

Hull: 6D+2

Shields: 1D+2

Sensors:

Passive: 20/0D

Scan: 40/1D

Search: 60/2D

Focus: 3/3D

Weapons:

2 Twin Laser Cannons (fire-linked)

Fire Arc: Front

Crew: 1 (pilot or co-pilot)

Scale: Starfighter

Skill: Starship gunnery

Fire Control: 3D

Space Range: 1-3/12/25

Atmosphere Range: 100-300/1.2/2.5 km

Damage: 3D+1

2 Retractable Blaster Cannons

Fire Arc: Turret

Crew: 1

Scale: Starfighter

Skill: Starship gunnery

Fire Control: 3D

Space Range: 1-3/12/25

Atmosphere Range: 100-300/1.2/2.5 km

Damage: 5D

Capsule: The jointly-designed *Crix*-class was named after Rebel/New Republic General Crix Madine, based on his Corellian background and for his effort to save Mon Calamari during the invasion of the World Devastators over a century earlier. Admiral Gar Stazi used a DC-4a shuttle to reach the Wheel for a meeting with Captain Mingo Bovark of the Fel Empire Imperial loyalists. After using Command Override Limpet Droids to take control of a turbolaser on Bovark's *Nune*-class Imperial shuttle, Stazi's shuttle was targeted. The shuttle managed to raise its shields in time and after Admiral Stazi boarded the shuttle, it left the Wheel.

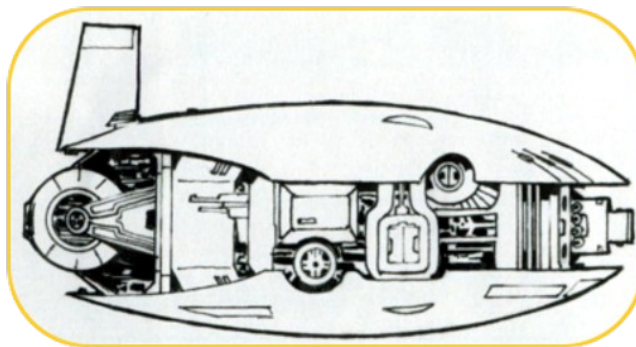

Addendum Personal- General Han Solo

The Diplomatic Courier is the civilian version of the assault shuttle. General Madine's mother wasn't happy about this one either...

CSS-1

Craft: Corellian Star Shuttle
Type: Transport
Era: Old Republic
Affiliation: General
Source: Suns of Fortune (p.110), Starship Stats (p.189-190)
Scale: Capital
Length: 80 meters
Skill: Capital ship piloting: CSS-1
Crew: 8 (pilot, co-pilot/navigator, communications, loadmaster, 4 stewards),
 Skeleton: 2/+8
Crew Skill: Varies
Passengers: 200
Cargo Capacity: 900 metric tons
Consumables: 3 years
Cost: 2.65 million credits (new)
Hyperdrive Multiplier: x1.5
Hyperdrive Backup: x12
Nav Computer: Yes
Space: 4
Atmosphere: 280; 800 kmh
Hull: 4D
Shields: 2D
Sensors:
Passive: 40/1D
Scan: 80/2D
Search: 100/3D
Focus: 5/4D

Capsule: Star Shuttles served the Republic in its last decades as diplomatic vessels, but some ships were modified for military service and were equipped with at least two turbolasers. They served in the Judicial Forces and fought in the Stark Hyperspace War, the Yinchorri Uprising, and the Clone Wars. The Corellian Star Shuttle *Perpetuus* transported Chancellor Palpatine to Theed following the Battle of Naboo. After the transformation of the Republic into an Empire, many Star Shuttles ended up in private hands. At least one

Star Shuttle was used to make up a secret retreat in 137 ABY.

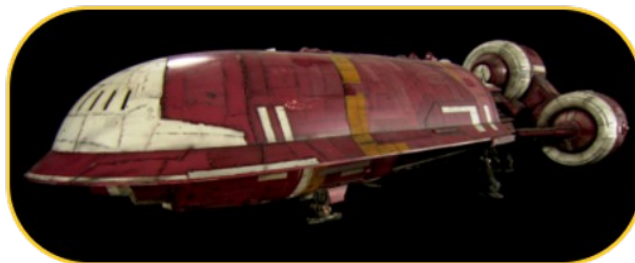

Addendum Personal- General Han Solo

I heard a rumor about this ship and was finally able to confirm it is based off a serving dish cover seen by the designer. Add the engines and suddenly you have a ship...

D-CLASS

"STARFARER" TRANSPORT

Craft: Corellian Engineering Corporation D-Class Transport

Type: Transport

Era: Rise of the Empire

Affiliation: General

Source: wookieepedia, stats by +Oliver Queen

Scale: Starfighter

Length: 27 meters

Skill: Space transports: D-class

Crew: 4 (pilot, co-pilot/engineer), gunners: 2, skeleton: 1/+5

Passengers: 8 (up to 40 depending on configuration)

Cargo Capacity: 60 metric tons

Consumables: 6 months

Cost: 80,000 credits (new), 35,000 credits (used)

Hyperdrive Multiplier: x2

Hyperdrive Backup: None

Nav Computer: Yes

Maneuverability: 2D

Space: 6

Atmosphere: 295; 850 kmh

Hull: 4D

Shields: 2D

Sensors:

Passive: 30/0D

Scan: 60/1D

Search: 80/1D+2

Focus: 4/2D

Weapons:

2 Double Laser Cannons

Fire Arc: 1 front, 1 turret

Crew: 2

Scale: Starfighter

Skill: Starship gunnery

Fire Control: 2D

Space Range: 1-5/12/20

Atmosphere Range: 100-300/1.2 /2.5 km

Damage: 3D+2

Capsule: The D-class Starfarer was a popular civilian starship manufactured by Corellian Engineering Corporation. Depending on the configuration it could be used for simple transport or as a troop transport as jump seats were built into the walls of the cargo bay.

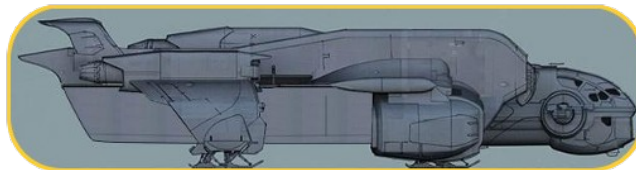

Addendum Personal- General Han Solo

I really can't say much about the Starfarer in terms of performance. I've never flown one, but they seem a capable enough transport. The lack of a backup hyperdrive doesn't inspire confidence, though...

DEFENDER CLASS LIGHT CORVETTE

Model: Corellian Defender-Class Light Corvette
Type: Light Freighter
Era: Old Republic
Affiliation: General
Source: Adapted from the Star Wars Old Republic MMORPG with stats by FreddyB (rpggamer.org)
Scale: Starfighter
Length: 54 Meters
Skill: Space Transports: Defender-Class Corvette
Crew: 7 (pilot, co-pilot/navigator, communication/sensors, engineer), Gunners: 2; skeleton 2/+15
Passengers: 18
Consumables: 2 Years
Cost: 100,000(new), 80,000(used)
Cargo Capacity: 350 tons
Hyperdrive Multiplier: x2
Hyperdrive Backup: x25
Nav Computer: Yes
Space: 4
Atmosphere: 200; 650 kmh
Maneuverability: 1D
Hull: 5D
Shields: 3D+2
Sensors:
Passive: 25/0D
Scan: 40/1D
Search: 55/2D+1
Focus: 2/3D+2

Weapons:

2 Twin TurboLaser Cannons

Fire Arc: Turret
Crew: 1
Scale: Starfighter
Fire Control: 1D+1

Space Range: 1-5/8/20
Atmosphere Range: 100-500/800/2 km
Damage: 5D+2

Capsule: Developed at the height of the Great War, the Defender was custom-built for the Jedi Order. The Jedi Council commissioned the starship after determining that Republic military vessels were not well-suited to the Jedi's more specialized missions. The Defender's exterior design is based on the consumer model corvette, but it has been outfitted with countless customized upgrades. The starship includes two levels. The formal upper level features diplomatic meeting rooms and an elegant conference room at the ship's center. The conference room contains a unique Holocomm system for secure communications with the Jedi Council. The Defender's lower level includes a cargo hold, a medical bay, and a small private space in which the Jedi can retreat for meditation. Despite the Jedi Order's commitment to peace, the ship is battle-ready. If circumstances warrant, the Defender is engineered with high-powered shields and twin turbolasers to engage the enemy.



Addendum Personal- General Han Solo

I rode in one of these from Kessel to Tatooine. Jabba the Hutt had a dozen of these old Defenders refurbished as cargo vessels. In the days before I won the Falcon from Lando, we had to fly one. For its size, the Defender flies exceptionally well despite the fact that

MISCELLANEOUS SHIPS

it's slower than two banthas trying to mate. The Defender has some of the best hull-to-shield ratio I have ever seen with a weapons system modern vessels could benefit from. If you ever had the chance, you should check out the Defender...

FA-504S

TRANSPORT

Craft: Corellian Engineering Corp. FA-504s
Transport

Type: Space transport

Era: Rebellion

Affiliation: General

Source: Wizards Website

Scale: Starfighter

Length: 28 meters

Skill: Space transports: FA-504s

Crew: 1

Passengers: 10

Cargo Capacity: 120 metric tons

Consumables: 2 months

Cost: 100,000 credits (new), 30,000 credits (used)

Hyperdrive Multiplier: x2

Hyperdrive Backup: x12

Maneuverability: 1D+2

Space: 5

Atmosphere: 295; 850 kmh

Hull: 3D+2

Shields: 1D

Sensors:

Passive: 30/1D

Scan: 50/2D

Search: 80/3D

Focus: 3/4D

Weapons:

Laser cannon

Fire Arc: Front

Crew: 1

Scale: Starfighter

Skill: Starship gunnery

Fire Control: 2D

Space Range: 1-3/12/25

Atmosphere Range: 100-300/1.2/2.5 km

Damage: 4D

Capsule: The FA-504s was a transport vessel pro-

duced by the C.E.C. during the Galactic Civil War. As a stand-alone design, the FA-504s was unable to compete with other transport models and was seen to be a less-popular design.



Addendum Personal- General Han Solo

I knew an Ithorian named Zal'kev, who was the captain to a '504 and other than gripin' about the hull to shield ratio he swore by that hunk of junk and loved his...

FREIGHT LOADING EXTERNAL ROVER

Craft: Corellian Engineering Corporation F-LER

Type: Freight shuttle/tug

Era: Old Republic, Rise of the Empire

Affiliation: General

Source: wookieepedia, stats by +Oliver Queen

Scale: Starfighter

Length: 3 meters

Skill: Space transports: F-LER

Crew: 1

Cargo Capacity: 5 tons

Consumables: 1 day

Cost: Not for sale publically (estimated 30,000 credits, used only)

Maneuverability: 1D+2

Space: 3

Atmosphere: 260; 750 kmh

Hull: 2D

Sensors:

Passive: 10/0D

Scan: 20/1D

Search: 30/2D

Focus: 2/2D+2

Weapons:

Harpoon and Tow Cable

Fire Arc: Turret

Crew: Pilot

Scale: Starfighter

Skill: Starship gunnery

Fire Control: 3D

Space Range: 1-5/15/30

Atmosphere Range: 100-500/1.5/3 km

Damage: 5D (towing purposes only)

(optional)

2 Light Laser Cannon (fire-linked)

Fire Arc: Turret

Crew: Pilot

Scale: Starfighter

Skill: Starship gunnery

Fire Control: 1D

Space Range: 1-3/6/9

Atmosphere Range: 100-300/600/900

Damage: 2D+2

(modified variant)

Double Laser Cannon

Fire Arc: Front

Crew: 1

Scale: Starfighter

Skill: Starship gunnery

Fire control: 1D

Space Range: 1-5/10/25

Atmosphere Range: 100-500/1/2.5 km

Damage: 4D

Capsule: The freight-loading external rover, also known as the F-LER, was a small, single-pilot starship that was manufactured by the Corellian Engineering Corporation for use in conjunction with the YT-1300 light freighter. The vehicle was developed by the CEC designer Tem Riffle, who was inspired by a tug that he had observed towing a YT-1200 freighter. The F-LER was designed to fit between the forward mandibles of a YT-1300 and Riffle envisaged that the rover could be used as a cargo-handler, to deliver freight to locations that the YT-1300 was too large to reach. CEC's executives favored Riffle's idea and many other designers came to the conclusion that the addition of a F-LER to a YT-1300 gave the freighter a sleeker look, while CEC's marketing department believed that YT-1300 owners would want to fill in the gap between the forward mandibles. A prototype F-LER was developed and successfully tested, and CEC subsequently began a limited production run of the design. CEC's marketing department also carried out a survey of 500 commercial YT-1300 pilots, to assess the F-LER's market potential.

MISCELLANEOUS SHIPS

However, just over a week into the F-LER's production run, the survey results were collated and revealed that most of the surveyed pilots were not interested in the F-LER, because they thought that it would get in the way when loading cargo. As a result, CEC ceased production of the vessel and the F-LER was never sold commercially. One hundred were saved to be used as tugs at CEC orbital assembly facilities, while the rest were scrapped. Eventually, a small number of F-LERs made it onto the open market and a few were modified and fitted with Ap/11 double laser cannons. Despite the F-LER's commercial failure, the research and development that went into the F-LER later resulted in the production of the YT-XC, a small exploration ship that was designed to be carried aboard the YT-1300.

from the conversation that these two thought that they had something truly special, that is until they realized why the F-LER never went to market in the first place. As it stands these two were forced to take whatever money they could get and ended up making more selling the stolen speeder truck than the F-LERs that they had stolen...

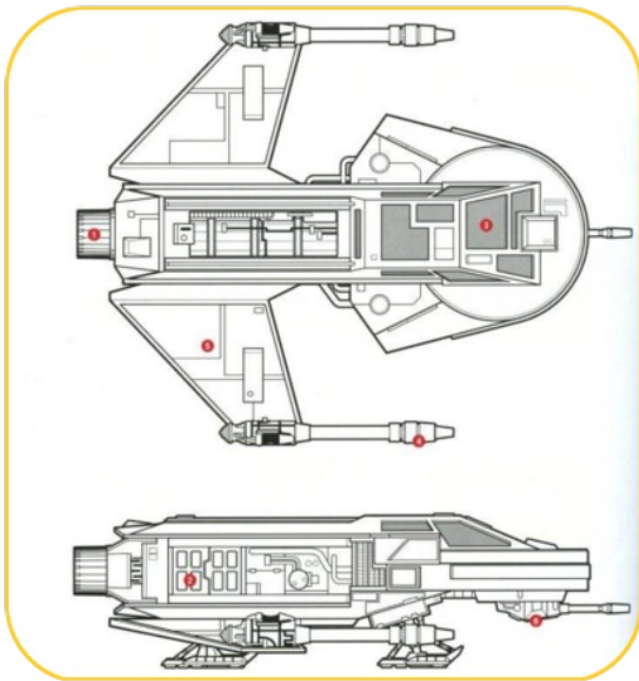

Addendum Personal- General Han Solo

I saw one of these at a trade show and really wasn't all that impressed with it. A couple of years later Chewie and I ran into a couple of guys who had a speeder truck full of the things selling them to anyone who wanted one for little to no credits. It seems that they happened upon a CEC storage facility and decided to help themselves to some crates before security showed up and they had to get out of there. I gathered

FXE

LUXURY SPACE YACHT

Craft: Corellian Industries FXE Space Yacht
Type: Space Yacht
Era: Old Republic, Rise of the Empire, Rebellion
Affiliation: General
Source: D6 Holocron
Scale: Starfighter
Skill: Space Transports, Repulsorlift Ops
Length: 57 meters
Crew: 9 (pilot, co-pilot/navigator, communications, steward); Gunners: 5; Skeleton: 3/+10
Crew Skills: Space Transports 4D, Repulsorlift Ops 4D, Culinary Arts 5D, Cooking 4D, Cultures 5D
Passengers: 10
Cargo Capacity: 300 metric tons
Consumables: 3 months
Cost: 275,000 (new), 190,000 (used)
Hyperdrive Multiplier: x1
Hyperdrive Backup: x8
Nav Computer: Yes
Maneuverability: 3D+2
Space: 11
Atmosphere: 435; 1,250 kmh
Hull: 6D
Shields: 4D (3D backup)
Sensors:
Passive: 40/1D
Scan: 80/2D
Search: 160/3D
Focus: 5/4D

Weapons:

Turbolaser Cannon (extra power supply)

Fire Arc: Turret
Crew: 2
Scale: Capital
Fire Control: 3D

Space Range: 3-15/36/75

Atmosphere: 6-30/72/150 km

Damage: 6D

2 Anti-Starfighter Laser Cannons

Fire Arc: Turret

Crew: 1

Scale: Starfighter

Fire Control: 2D

Space Range: 1-5/12/25

Atmosphere: 2-10/24/50 km

Damage: 5D

2 Double Laser Cannons

Fire Arc: Dorsal Turrets (1 fore, 1 aft)

Crew: 1, co-pilot; 1, pilot (can be switched to the communications station)

Scale: Starfighter

Skill: Starship Gunnery

Fire Control: 2D+2

Space Range: 1-3/12/25

Atmosphere Range: 100-300/1.2/2.5 km

Damage: 4D+2

Game Notes: All weapons are fully retractable and sensor-proofed.

Capsule: Well equipped for guests, this space transport can also hold its own in a combat situation long enough to make an emergency jump into hyperspace. With the hidden turbolaser even a capital ship would be surprised for a time.



Addendum Personal- General Han Solo

Similar in design to the Corellian Starspeed Yacht, the FXE is an overpriced toy for people who probably have no business flying a ship to begin...

G9

RIGGER TRANSPORT

Craft: Corellian Engineering Corporation G9 Rigger Transport

Type: Light freighter

Era: Old Republic

Affiliation: General

Source: The Clone Wars Campaign Guide

Scale: Starfighter

Length: 34.1 meters

Skill: Space transports: G9 Rigger

Crew: 2, skeleton: 1/+5

Passengers: 6

Cargo Capacity: 70 metric tons

Consumables: 1 month

Cost: 85,000 credits (new), 45,000 credits (used)

Hyperdrive Multiplier: x3

Backup Hyperdrive: No

Nav Computer: Yes

Space: 3

Atmosphere: 240; 700 kmh

Hull: 3D+1

Sensors:

Passive: 10/0D

Scan: 20/1D

Search: 35/1D+2

Focus: 2/2D

Weapons:

Double Light Laser Cannon (fire-linked)

Fire Arc: Front

Crew: Pilot or Co-Pilot

Scale: Starfighter

Skill: Starship gunnery

Fire Control: 1D

Space Range: 1-3/12/25

Atmosphere Range: 100-300/1.2/2.5 km

Damage: 4D

Light Laser Cannon

Fire Arc: Front or rear

Crew: Pilot or Co-pilot

Scale: Starfighter

Skill: Starship gunnery

Fire Control: 2D

Space Range: 1-3/12/25

Atmosphere Range: 100-300/1.2/2.5 km

Damage: 3D

Capsule: The G9 Rigger freighter was a type of Corellian freighter. It was already an aging model by the time of the Clone Wars. It was slow and unwieldy compared to starfighters. While not a military design, at least one such vessel, the *Twilight*, saw action in the Clone Wars, when Anakin Skywalker used it to escape Teth and was intercepted over Tatooine by Rogue-class starfighters. The G9 Rigger has 3 blaster cannons located on the struts projecting out of the ship.



Addendum Personal- General Han Solo

I'm told that my now dead father-in-law was the captain of a former spice freighter named 'the Twilight', my daughter loved the name saying it was 'dreamy...' whatever that means. During the Clone Wars this was his personal vessel. Knowing how the man turned out, I have to wonder if the story is even true as I don't see him settling for a G9 as his personal vessel...

G11

INTERCEPTOR

Craft: Corellian Engineering Corporation
Type: Interceptor
Era: Rebellion, New Republic
Affiliation: Alliance to Restore the Republic, New Republic
Source: AdamKop, stats by +Oliver Queen
Scale: Starfighter
Length: 61.2 meters
Skill: Space Transport: G11
Crew: 2 (pilot, co-pilot/navigator), 2 gunners; skeleton 1/+5
Passengers: None
Crew Skill: Sensors 4D, Space Transport Piloting 5D, Starship Gunnery 4D+2, Starship Shields 3D+1
Cargo Capacity: 30 metric tons
Consumables: 3 months
Cost: 145,000 credits (new), 40,000 credits (used)
Hyperdrive Multiplier: x2
Hyperdrive Backup: x12
Nav Computer: Yes
Maneuverability: 3D+1
Space: 8
Atmosphere: 365; 1,050 kmh
Hull: 4D+2
Shields: 2D
Sensors:
Passive: 40/1D
Scan: 80/2D
Search: 100/3D
Focus: 5/4D

Weapons

Quad Laser Cannon

Fire Arc: Turret
Crew: 1 (may coordinate)
Scale: Starship
Skill: Starship Gunnery

Fire Control: 2D
Space Range: 1-3/12/25
Atmosphere Range: 100-300/1.2/2.5 km
Damage: 6D

Double Blaster Cannon

Fire Arc: Front
Crew: Pilot or co-pilot (may coordinate)
Scale: Starfighter
Skill: Starship gunnery
Fire Control: 2D
Space Range: 1-9/18/36
Atmosphere Range: 100-900/1.8/3.6 km
Damage: 4D

Ion Cannon

Fire Arc: Turret (rear, left, right)
Crew: 1 (may coordinate)
Scale: Starship
Skill: Starship Gunnery
Fire Control: 2D
Space Range: 1-10/25/50
Atmosphere Range: 1-10/25/50 km
Damage: 5D

Concussion Missile Launcher

Fire Arc: Front
Crew: Pilot or Co-pilot (may coordinate)
Scale: Starfighter
Skill: Starship gunnery
Fire Control: 2D
Space Range: 1/3/7
Atmosphere Range: 50-100/300/700
Ammo: 3 missiles
Damage: 9D

Point-Defense System

Fire Arc: Turret
Crew: None (automated)
Scale: Starship
Skill: None
Fire Control: (automated)
Space Range: 3
Atmosphere Range: 300m
Damage: Special
Notes: When the PDS is engaged approaching missiles are fired upon with a

MISCELLANEOUS SHIPS

sustained barrage of blaster fire. This increases the difficulty for the missile to hit its target (target number +8). If the the missile skill roll falls within the adjusted range it is destroyed. Example: a missile fired at long range (20) approaches the ship. The PDS automatically engages. The missile misses on less than 19, is destroyed 20-27 and hits on 28+.

Capsule: Designed with the specific intent of hunting down and stopping smugglers, pirates and people breaking locals, sector and galactic law the G11 Interceptor is specifically designed to make lawbreakers think twice about engaging in unlawful behavior.



Addendum Personal- General Han Solo

Having been chased off of Corellia by one of these things I can tell you that the specifications for the ship don't convey what a nasty piece of work they truly are. The G11 Interceptor has enough fire power to make a full grown Wookiee wish that he'd never been born. I have seen Corellian Corvettes turn and haul jets to get away from these things. So lemme give you half a credits worth of advice for free, if you ever find yourself on the wrong side of the law and see one of these things coming, you had better rethink your position in life and run in the other direction. Quick, fast and in a blasted hurry...

G-N2

REPUBLIC GUNSHIP

Type: Corellian Engineering Corporation GN-2 Republic Gunship

Type: Gunship

Era: Old Republic (between 3996 to 3976 BBY)

Affiliation: Galactic Republic

Source: FreddyB (rpggamer.org)

Scale: Capital

Length: 92 Meters

Skill: Capital Ship Piloting: Republic Gunship

Crew: 125; Skeleton **Crew:** 30/+10

Crew Skill: Astrogation 4D, Capital Ship Piloting 5D+1, Capital Ship Shields 4D+2, Capital Ship Gunnery 5D+1, Sensors 4D

Passengers: 15 (Troops)

Cargo Capacity: 800 tons

Consumables: 18 months

Cost: 1.1 Million credits (used)

Hyperdrive Multiplier: x5

Hyperdrive Backup: x24

Nav Computer: Yes

Maneuverability: 1D+2

Space: 6

Atmosphere: 350, 950 kmh

Hull: 2D+2

Shields: 1D

Sensors:

Passive: 20/0D

Scan: 40/1D

Search: 80/2D

Focus: 2/3D

Weapons:

Turbolaser Cannon

Fire Arc: Turret

Crew: 2

Scale: Capital

Skill: Capital ship gunnery

Fire Control: 2D

Space Range: 2-10/24/60

Atmosphere Range: 4-20/48/120 km

Damage: 2D+2

2 Twin Laser Cannons

Fire Arc: Turret

Crew: 1

Scale: Starfighter

Skill: Starship gunnery

Fire Control: 3D

Space Range: 1-2/10/20

Atmosphere Range: 1-2/10/20 km

Damage: 4D+1

Capsule: The Corellian Engineering Corporation Republic Gunship was designed and built between the Sith War and the Mandalorian Wars. These small, fast and heavily-armed, vessels comprised most of the Republic Navy, and served with distinction under the command of the Jedi Revan and Malak. However, after the two Jedi turned against the Republic these vessels suffered the brunt of the following war. Capable of carrying 6 Starfighters in external racks, the Gunships also acted as the carriers of the Republic fleet, but even in this role found themselves seriously outclassed by the masses of Star Forge-produced *Leviathan*-Class Destroyers and Sith Starfighters. Republic Gunships were the most common capital ship of their era, but the majority were destroyed in the war against the Sith, and few survived the millennia until the rise of the Galactic Empire and those that did were relegated to service on the galactic rim on backwater worlds which could not afford newer and better capital ships.



Addendum Personal- General Han Solo

This was back during the time when the CEC was making gunships and military craft. Wait a second - that's most of what is in this book...

GREK

TROOP SHUTTLE

Craft: Corellian Engineering Grek-class troop shuttle

Type: Ship-to-ship troop shuttle

Era: Rise of the Empire

Affiliation: General, Galactic Empire

Source: Pirates & Privateers (pages 87-88)

Scale: Starfighter

Length: 30 meters

Skill: Space transports: Grek shuttle

Crew: 2

Crew Skill: Varies widely

Passengers: 50

Cargo Capacity: 500 kilograms

Consumables: 1 day

Cost: 40,000 credits (new), 18,000 credits (used)

Maneuverability: 1D

Space: 6

Atmosphere: 330; 950 kmh

Hull: 3D

Sensors:

Passive: 15/0D

Scan: 30/1D

Search: 50/3D

Focus: 2/3D+2

Weapons:

Laser Cannon

Fire Arc: Front

Crew:

Scale: Starfighter

Skill: Starship gunnery

Fire Control: 1D

Space Range: 1-3/12/25

Atmosphere Range: 100-300/1.2/2.5 km

Damage: 4D

Capsule: It was 30 meters long, shaped approximately like the Aurebesh letter Grek, armed with a computer-controlled laser cannon, and could transport up to

50 troops, with minimal cargo on the side. The crew amounted to a pilot and co-pilot. Grek-class shuttles were often stationed aboard Nebulon-B frigates for use by the Imperial forces.

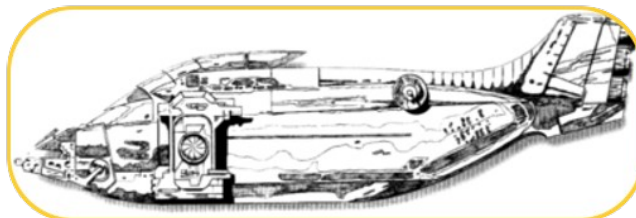

Addendum Personal- General Han Solo

If I had a credstick for every warship, gunboat and troop transport I'd be filthy rich by now...

HLEAF-500

STARFIGHTER

Craft: Corellian Heavy/Light Attack Fighter-500

Type: Multi-purpose starfighter

Era: Rise of the Empire

Affiliation: General, Alliance to Restore the Republic, Galactic Empire

Source: Suns of Fortune (p.108-109), Cracken's Threat Dossier (p.142)

Scale: Starfighter

Length: 12 meters

Skill: Starfighter piloting: HLEAF-500

Crew: 1

Crew Skill: Varies widely

Cargo Capacity: 65 kilograms

Consumables: 2 days

Cost: 40,000 (used)

Hyperdrive Multiplier: x2

Hyperdrive Backup: No

Nav Computer: Yes

Maneuverability: 4D

Space: 12

Atmosphere: 450; 1,300 kmh

Hull: 2D

Shields: 2D

Sensors:

Passive: 15/0D

Scan: 25/1D

Search: 50/1D+2

Focus: 2/2D

Weapons:

2 Laser Cannons

Fire Arc: Front

Crew: 1

Scale: Starfighter

Skill: Starship gunnery

Fire Control: 1D

Space Range: 1/3/7

Atmosphere Range: 50-100/300/700

Damage: 5D

2 Proton Torpedo Launchers

Fire Arc: Front

Crew: 1

Scale: Starfighter

Skill: Missile weapons

Fire Control: 2D

Space Range: 1/3/7

Atmosphere Range: 50-100/300/700

Ammo: 1 torpedo each

Damage: 9D

Capsule: A modified and upgraded version of the LAF-250 starfighter, the Heavy/Light Attack Fighter 500 boasts a number of significant improvements over its predecessor. Built on the same frame as the LAF-250, the HLEAF-500 has powerful SoroSuub 9X2 fusial thrust engines that give the craft better performance, acceleration, and handling. To increase the starfighter's offensive capabilities, additional weapons hardpoints were added, allowing the HLEAF-500 to be equipped with proton torpedo launchers

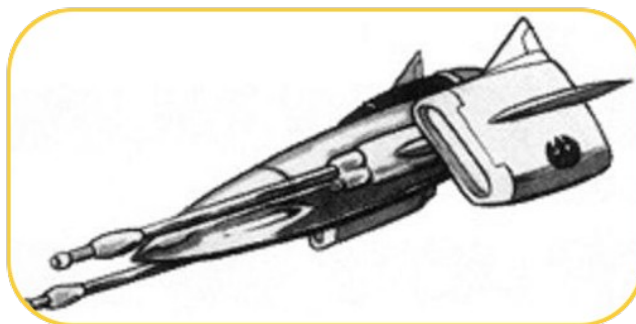

Addendum Personal- General Han Solo

Again, here is a starfighter with the hull and shield rating of a TIE fighter, but they could launch proton torpedoes. Oh and don't think that the CEC didn't notice the distinct similarities between the looks of the HLEAF-500 and the A-Wing ...

INT-66

HEAVY INTERCEPTOR

Craft: Corellian Engineering Corporation INT-66

Type: Heavy Interceptor

Era: Rise of the Empire

Affiliation: General

Source: Adventure Journal 4

Scale: Starfighter

Length: 50 meters

Skill: Space transports: INT-66

Crew: 1, gunners: 2

Crew Skill: Space transports 5D, starship gunnery 5D+1, starship shields 4D+2

Passengers: 3

Cargo Capacity: 50 metric tons

Consumables: 4 months

Cost: 350,000 credits (new), 275,000 credits (used)

Hyperdrive Multiplier: x2

Hyperdrive Backup: x12

Nav Computer: Yes

Maneuverability: 2D

Space: 5

Atmosphere: 295; 850 kmh

Hull: 5D

Shields: 2D

Sensors:

Passive: 20/1D

Scan: 45/1D+2

Search: 75/2D+2

Focus: 3/3D+2

Weapons:

2 Turbolasers (fire-linked)

Fire Arc: Front

Crew: 1 (pilot)

Scale: Starfighter

Skill: Starship gunnery

Fire Control: 2D

Space Range: 1-4/15/30

Atmosphere Range: 100-400/1.5/3 km

Damage: 7D

4 Multi-Repeat Blasters (fire-linked)

Fire Arc: Front

Crew: 1

Scale: Starfighter

Skill: Starship gunnery

Fire Control: 2D

Space Range: 1-3/12/20

Atmosphere Range: 100-300/1.2/2 km

Damage: 4D

Double Pulse Laser Cannon

Fire Arc: Turret

Crew: 1

Scale: Starfighter

Skill: Starship gunnery

Fire Control: 3D

Space Range: 1-3/12/25

Atmosphere Range: 100-300/1.2/2.5 km

Damage: 5D+2

Capsule: The INT-66 is Corellian Engineering's attempt of a transport/fighter system comparable to Arakyd's Helix Light Interceptor. The INT-66 Heavy Interceptor features an impressive complement of weapons and requires one pilot and two gunners to operate. Weapons and shields make these vessels excellent gunboats. For this reason, Heavy Interceptors are usually only available to the military. But it is also used by independant systems for customs and patrol duties as well as light defense mission profiles. The ships only weakness is the somewhat underpowered drive section, only allowing modest sublight speed. Thus, a common modification to the Heavy Interceptor is the installation of a heavier power generator and upgraded sublight engines.

MISCELLANEOUS SHIPS

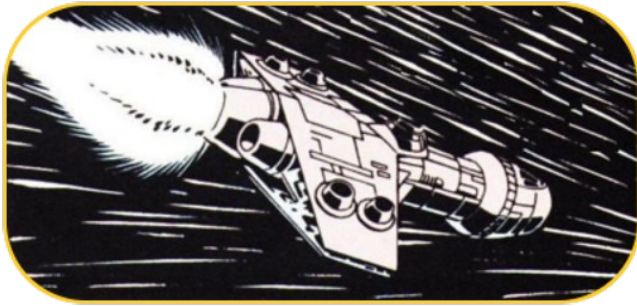

Addendum Personal- General Han Solo

Slow and bulky, but with the hull-to-shield ratio that allows the pilot and crew to keep the thing going as they open fire with enough on-board weaponry to take out a small moon. You gotta hand it to the CEC, half the time they're either not giving their customers enough to protect themselves or more protection and firepower than they'll ever need...

KR-TB

"DOOMTREADER"

Craft: Corellian Engineering Corporation KR-TB "Doomtreader"

Type: Medium Transport

Era: Old Republic

Affiliation: General

Source: The Clone Wars Campaign Guide (Pages 78-79)

Scale: Starfighter

Length: 50 meters

Skill: Space transport: KR-TB Doomtreader

Crew: 2, plus astromech, skeleton: 1/+5

Passengers: 6

Cargo Capacity: 350 metric tons

Consumables: 1 month

Cost: 350,000 credits (new), 70,000 credits (Used)

Hyperdrive Multiplier: x2

Hyperdrive Backup: x15

Nav Computer: Yes

Maneuverability: 1D

Space: 6

Atmosphere: 310; 900 kmh

Hull: 6D

Shields: 2D

Sensors:

Passive: 30/1D

Scan: 60/1D

Search: 90/2D

Focus: 4/3D

Weapons:

Dual Laser Cannons

Fire Arc: Front

Crew: 1

Scale: Starfighter

Skill: Starship gunnery

Fire Control: 2D

Space Range: 1-3/10/20

Atmosphere Range: 100-300/1/2 km

Damage: 6D

Capsule: The KR-TB "Doomtreader" was a freighter produced by Corellian Engineering Corporation. It had expansive cargo holds, heavy deflector shields and dual laser cannons, but came at a relatively high price.

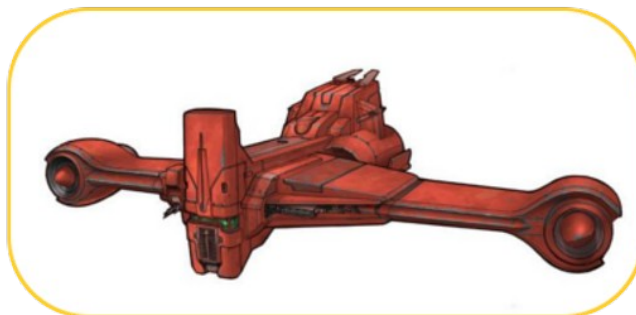

Addendum Personal- General Han Solo

Relatively high price indeed, but if you can find one of the KR's used and make some modifications like adding an extra gun or some more living space then this freighter becomes a decent enough ship to operate out of with all the firepower and hull-to-shield ratio that you could want...

KR-500

SPACEWAYS TRANSPORT HIGH PERFORMANCE LIGHT FREIGHTER

Craft: KS-500 Spaceways Transport High Performance light freighter
Type: Light freighter
Era: Rise of the Empire, Rebellion
Affiliation: General
Source: Originally presented in Polyhedron #68, Stats tweaked by Keith A. Kilburn, art by nfeyma
Scale: Starfighter
Length: 28.3 meters
Skill: Space Transports: KS-500 Spaceways Transport High Performance light freighter
Crew: 2
Passengers: 6
Crew Skill: Vary
Consumables: 2 Months
Cost: 125,000 credits (35,000 credits used)
Cargo Capacity: 70 Tons
Hyperdrive Multiplier: x1
Hyperdrive Backup: x12
Nav Computer: Yes
Space: 5
Atmosphere: 295, 850 kmh
Maneuverability: 1D
Hull: 4D
Shields: 1D
Sensors:
Passive: 10/0D
Scan: 25/1D
Search: 40/2D
Focus: 2/3D
Weapons:
2 Laser Cannons
Fire Arc: Turret
Crew: 1
Scale: Starfighter

Skill: Starship gunnery
Fire Control: 2D
Space Range: 1-3/12/25
Atmosphere Range: 100-300/1.2/2.5 km
Damage: 4D

Capsule: The KS-500 Spaceways Transport light freighter was a standard light freighter produced by the Corellian Engineering Corporation. They were high performance vehicles which could be easily modified, as was evidenced with the *Fatal Vision*.

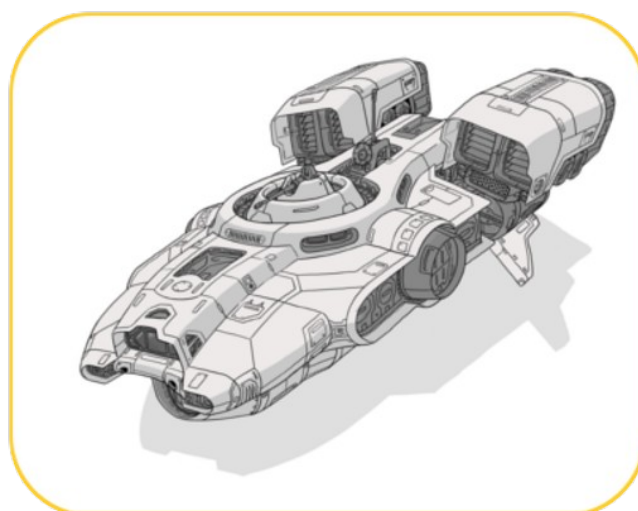

Addendum Personal- General Han Solo

For the time period in which the KS-500 was released, it was the ship and a very high performance vehicle that was sought after by the elite and wealthy. Just like most things that are considered collectors' items, the KS-500 fell out of favor and the elite moved on to something different and over time the KS-500 was discontinued. You can still buy them used and they are a decent enough ship...

LAF-250

STARFIGHTER

Craft: Corellian Light Attack Fighter-250

Type: Multi-purpose starfighter

Era: Rise of the Empire

Affiliation: General Corellian Defense

Source: Suns of Fortune (p.108), Cracken's Threat Dossier (p.141)

Scale: Starfighter

Length: 12 meters

Skill: Starfighter piloting: light attack fighter

Crew: 1

Crew Skill: Varies widely

Cargo Capacity: 65 kilograms

Consumables: 2 days

Cost: 35,000 (used)

Hyperdrive Multiplier: x2

Nav Computer: Yes

Maneuverability: 3D

Space: 5

Atmosphere: 350; 1,000 kmh

Hull: 2D

Shields: 1D

Sensors:

Passive: 15/0D

Scan: 25/1D

Search: 50/1D+2

Focus: 2/2D

Weapons:

2 Laser Cannons

Fire Arc: Front

Crew: 1

Scale: Starfighter

Skill: Starship gunnery

Fire Control: 1D

Space Range: 1/3/7

Atmosphere Range: 50-100/300/700

Damage: 5D

Capsule: The Light Attack Fighter Model 250 is the primary starfighter used by the Corellian Defense Force and CorSec. Designed to combine the roles of space superiority fighter and patrol craft, the LAF-250 fulfills these functions adequately, but excels at neither. While a capable, well-made starfighter, its engines and shields are somewhat underpowered and its armament consists of just a twin-linked pair of laser cannons, leaving the LAF-250 at a disadvantage against faster, more heavily-armed craft.

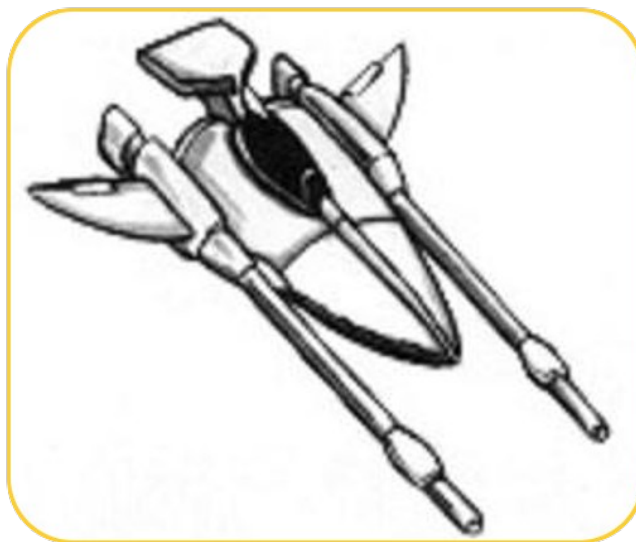

Addendum Personal- General Han Solo

The CL-1C, the HLAF-500 and before them the LAF-250, talk about going from bad to worse...The Laf-250 (we used to call them 'laughs'...) was the forerunner to the HLAF, however where the HLAF was a marked improvement, the LAF couldn't catch a jawa if it was trying to escape in a sandcrawler. It's pretty bad when a Ghtroc stock freighter loaded with cargo can outrun, outfight and out class your 'space superiority' fighter and patrol craft...

MONARCH CLASS SHUTTLE

Craft: Corellian Engineering Corporation

Monarch-class Shuttle

Type: Transport shuttle

Era: Rise of the Empire

Affiliation: Galactic Republic, General

Source: wookieepedia, stats by +Oliver Queen

Scale: Starfighter

Length: 31 meters

Skill: Space transports: *Monarch-class*

Crew: 1

Passengers: 3

Cargo Capacity: 1.5 metric tons

Consumables: 1 month

Cost: 65,000 credits (new), 42,000 credits (used)

Hyperdrive Multiplier: None

Hyperdrive Backup: None

Nav Computer: None

Maneuverability: 2D

Space: 4

Atmosphere: 280; 800 kmh

Hull: 3D+1

Shields: 2D

Sensors:

Passive: 20/1D

Scan: 40/1D+2

Search: 50/2D

Focus: 3/2D+2

Weapons:

Double Blaster Cannon

Fire Arc: Front

Crew: 1

Scale: Starfighter

Skill: Starship gunnery

Fire Control: 2D

Space Range: 1-3/12/25

Atmosphere Range: 100-300/1.2/2.5 km

Damage: 4D

Capsule: The *Monarch*-Class armored shuttle was produced in the years before the blockade of Naboo and went to market during that time; although sales were good the Monarch never gained its market place footing. By the end of the Clone Wars the Monarch was phased out and taken off the market despite gaining some limited use during the war...



Addendum Personal- General Han Solo

There really isn't much to them, it's sort of like 4 people tryin' to fit into a shoe box...

MT DROPSHIP

Craft: Corellian Engineering Corporation MT Dropship

Type: Troop landing craft

Era: New Republic, Legacy

Affiliation: New Republic, Galactic Alliance

Source: Legacy Era Campaign Guide (pages 146-147)

Scale: Capital

Length: 65 meters

Skill: Space transports: MT Dropship

Crew: 15, gunners: 40

Crew Skill: Astrogation 3D+2, capital ship piloting 5D, capital ship shields 5D, sensors 3D

Passengers: 200 (troops)

Cargo Capacity: 500 metric tons

Consumables: 1 week

Cost: 600,000 credits (new), 300,000 credits (used)

Maneuverability: 1D

Space: 5

Atmosphere: 295; 850 kmh

Hull: 1D

Shields: 1D

Sensors:

Passive: 20/0D

Scan: 40/1D

Search: 60/2D

Focus: 3/3D

Weapons:

8 Laser Cannons

Fire Arc: Turret

Crew: 3

Scale: Starfighter

Skill: Starship gunnery

Fire Control: 3D+2

Space Range: 1-3/12/25

Atmosphere Range: 100-300/1.2/2.5 km

Damage: 6D

8 Concussion Missile Launchers

Fire Arc: Turret

Crew: 2

Scale: Starfighter

Skill: Starship gunnery

Fire Control: 3D

Space Range: 1/3/7

Atmosphere Range: 100/300/700

Ammo: 3 missiles each

Damage: 9D



Capsule: The conical dropship had its command center at the top of the cone structure. Here, the commanders and pilots had full view of the surrounding areas, with configurations for view out the sides during atmospheric operations and out the top of the craft when in space. On top of the conical ship was the communications arrays. Below the command center was an array of laser cannons and missile launchers. The lowest levels of the craft would open up to deploy troops and vehicles. Despite their armored and shielded hulls, the MT dropships needed escorts to reach a battlefield. The Alliance used them both for troop deployment and as evacuation transports and they served as mobile command and communications centers, when on the ground.

Addendum Personal- General Han Solo

All the weapons and guns they have mounted on this

MISCELLANEOUS SHIPS

thing to transport 200 troops and the hull-to-shield ratio will get them all killed before they even land the thing. I'm not sure what they were thinking when they made this, but I'm glad that I've never had to fly one...

NEMESIS

PATROL SHIP

Craft: Corellian Engineering Corporation
Nemesis-class Patrol Ship

Type: Light patrol ship

Era: New Republic, Legacy

Affiliation: General

Source: Legacy Era Campaign Guide (page 218)

Scale: Starfighter

Length: 34 meters

Skill: Space transports: *Nemesis* Patrol Ship

Crew: 4, gunners: 4, skeleton: 2/+5

Passengers: 10

Cargo Capacity: 5 metric tons

Consumables: 6 months

Cost: 180,000 credits (new), 95,000 credits (used)

Hyperdrive Multiplier: x2

Hyperdrive Backup: No

Nav Computer: Yes

Maneuverability: 1D

Space: 5

Atmosphere: 295; 830 kmh

Hull: 5D

Shields: 2D

Sensors:

Passive: 30/0D

Scan: 60/1D

Search: 90/2D

Focus: 4/4D

Weapons:

4 Laser Cannons

Fire Arc: Turret

Crew: 1

Scale: Starfighter

Skill: Starship gunnery

Fire Control: 2D

Space Range: 1-3/12/25

Atmosphere Range: 100-300/1.2/2.5 km

Damage: 5D*

Carried Craft: 6 speeder bikes

Game Note: The four laser cannons can be fire-linked to be operated solely by the pilot, doing 6D damage.

Capsule: Created before the Sith–Imperial War, the *Nemesis*-class was marketed toward smaller worlds and governments in the Outer Rim. In addition to serving local administrations and law enforcement agencies, many *Nemesis*-class ships ended up in the hands of Black Sun, where they were used in operations in the distant and isolated regions of the galaxy. Black Sun employed a *Nemesis*-class patrol ship during the skirmish on Iego.



Addendum Personal- General Han Solo

I've seen the production work up for these and really can't say much more than that...

PPB

POCKET PATROL BOAT

Craft: Corellian Engineering Corporation Pocket Patrol Boat

Type: Stock patrol boat

Era: Old Republic, Rise of the Empire, Rebellion

Affiliation: General

Source: Suns of Fate (p.109), stats by +Oliver Queen

Scale: Starfighter

Length: 26 meters

Crew: 2 (pilot, sensor operator/gunner); Skeleton: 1/+5

Passengers: None

Cargo Capacity: 20 metric tons

Consumables: 2 weeks

Cost: 70,000 credits

Hyperdrive Multiplier: None

Hyperdrive Backup: None

Nav Computer: None

Maneuverability: 2D+1

Space: 8

Atmosphere: 365; 1,050 kmh

Hull: 2D+2

Shields: 3D

Sensors:

Passive: 30/2D

Scan: 60/3D

Search: 90/4D

Focus: 4/4D+1

Weapons:

Heavy Laser Cannon

Fire Arc: Turret

Crew: 1

Scale: Starfighter

Skill: Starship gunnery

Fire Control: 2D

Fire Rate: 1

Space Range: 1-3/12/25

Atmosphere Range: 100-300/1.2/2.5 km

Damage: 5D

Capsule: A peculiar vessel, CEC's Pocket Patrol Boat is really an oversized starfighter designed for long-range, intersystem patrol duty. Used primarily by the Corellian Defense Force, the PPB can be found throughout the Corellian Sector, patrolling and policing the space lanes. Equipped with sophisticated sensors, the fast and relatively maneuverable PPB can overtake most free traders and blockade runners. The PPB's speed comes at the cost of armor, leaving it vulnerable to starfighters and well-armed attack craft.

Mounted in a turret atop the small PPB is a Taim & Bak heavy laser cannon, which gives the patrol boat a powerful punch for a ship of its size. Unfortunately, the power requirements of this weapon on a starfighter's power plant means it has a hefty recharge time. While useful against light and medium freighters, this high-powered, slow-firing armament is far less effective against starfighters. This limitation has done quite a bit to establish the PPB as a "second-rate" starfighter when compared to other vessels.



Addendum Personal- General Han Solo

There really isn't much to say about the PPB that the capsule and its specifications don't already tell you, other than my youngest son once called it the 'PBJ' which made me and Chewie laugh to no end and that's what we call it now...

PB-950

PATROL BOAT

Craft: Corellian Engineering Corporation PB-950 Patrol Boat

Type: Stock patrol boat

Era: Old Republic, Rise of the Empire, Rebellion

Affiliation: General

Source: Suns of Fortune (p.109), Pirates & Privateers (p.81-82), The Far Orbit Project (p.81-82), tweaks by +Oliver Queen

Scale: Starfighter

Length: 37 meters

Skill: Space transports: PB-950 patrol boat

Crew: 2 (pilot, co-pilot/navigator), gunners: 2;

Skeleton: 1/+10

Passengers: 8

Cargo Capacity: 180 metric tons

Consumables: 3 months

Cost: 150,000 credits

Hyperdrive Multiplier: x3

Hyperdrive Backup: x12

Nav Computer: Yes

Maneuverability: 1D

Space: 8

Atmosphere: 365; 1,050 kmh

Hull: 5D

Shields: 3D

Sensors:

Passive: 30/1D

Scan: 60/2D

Search: 90/4D

Focus: 4/4D+1

Weapons:

Quad Laser Cannon

Fire Arc: Turret (left, right, rear)

Crew: 1 (pilot or co-pilot)

Scale: Starfighter

Skill: Starship gunnery

Fire Control: 2D

Space Range: 1-3/12/25

Atmosphere Range: 100-300/1.2/2.5 km

Damage: 5D

2 Medium Ion Cannons

Fire Arc: Turret (front, left, right)

Crew: 1

Scale: Starfighter

Skill: Starship gunnery

Fire Control: 3D

Space Range: 1-3/7/36

Atmosphere Range: 100-300/700/3.6 km

Damage: 4D (ionization damage)

Concussion Missile Tube

Fire Arc: Front

Crew: 1 (pilot or co-pilot)

Scale: Starfighter

Skill: Missile weapons

Fire Control: 2D

Space Range: 1/3/7

Atmosphere Range: 50-100/300/700

Ammo: 8 missiles each

Damage: 9D

Capsule: An old model patrol boat in production for nearly three centuries, the PB-950 can still be found in service with Imperial Customs and local system defense forces throughout the galaxy, particularly beyond the Inner Rim. A rugged, reliable ship, the clunky PB-950 is known for its ability to withstand considerable punishment, as well as for possessing enough firepower to deal with starfighters and other small vessels it might encounter. While the venerable patrol boat is slowly being phased out in favor of newer models, PB-950 has become increasingly popular among smugglers and pirates, who still appreciate many of its qualities. Mounted in turrets on either side of the ship's command deck are two medium ion cannons. Intended to immobilize smugglers' vessels before they could escape, pirates use stock ion cannons to disable their prey. The PB-950 also has a concussion missile launcher and an aft turret-mounted quad laser for dealing with starfighters.

MISCELLANEOUS SHIPS

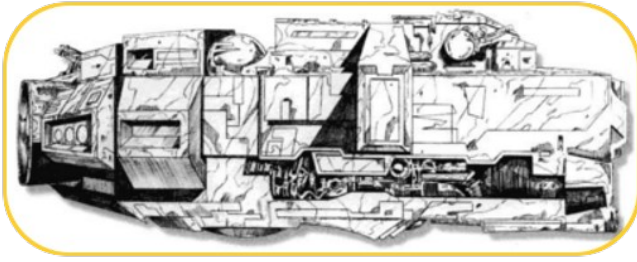

Addendum Personal- General Han Solo

I love that the writer flip-flops back and forth between the Imperials and the criminal elements in the universe in some vain attempt to appeal to both customer bases. Personally I think that the PB-950 looks like my youngest son's toy magno-train engine that he used to play with as child...

REPUBLIC

STAR SHUTTLE

Craft: Corellian Engineering Corporation

Republic Star Shuttle

Type: Shuttle

Era: Old Republic

Affiliation: General

Source: FreddyB (rpggamer.org)

Scale: Starfighter Length

Length: 60 m

Skill: Space Transports - Star Shuttle

Crew: 3

Crew Skill: varies

Passengers: 20

Consumables: 3 months

Cost: 75,000 (used)

Cargo Capacity: 150 tons

Hyperdrive Multiplier: x2

Hyperdrive Backup: x20

Nav Computer: Yes

Space: 5

Atmosphere: 295; 850 kmh

Maneuverability: 1D

Hull: 3D+2

Shields: None

Sensors:

Passive: 15/0D

Scan: 35/1D

Search: 60/2D

Focus: 3/2D+2

Capsule: Based visually off of the Zentine Dynamics shipyards at Foerost's *Ministry*-class orbital shuttles, The CEC Republic Star Shuttle did much the same job for the Old Republic that the Lambda and Sentinel class shuttles do for the Empire, acting as small transport ships for both personnel and supplies, as well as ship to shore transports for large capital ships. However the Star Shuttle was far bigger than a Lambda shuttle, and was not as practical for this task.

Since the fall of the Republic most of these vessels have been sold off to private concerns, and many have now found themselves in the hands of free traders where they serve as completely practicable space transports and cargo ships.



Addendum Personal- General Han Solo

It has the same vague look of the Lambda-class shuttles that the Empire uses. Go figure...

S-100

STINGER-CLASS STARFIGHTER

Craft: Corellian Engineering Corp S-100 Stinger-class Starfighter

Type: Starfighter

Era: Old Republic

Affiliation: Jedi Order, General

Source: Power of the Jedi Sourcebook (page 60), D6 Holocron, art by Kendall Darkmere

Scale: Starfighter

Length: 3.5 meters

Skill: Starfighter piloting: S-100 Stinger

Crew: 1

Crew Skill: 5D in all applicable skills

Cargo Capacity: 10 kilograms

Consumables: 1 month

Cost: 465,000 (new), 310,000 (used)

Hyperdrive Multiplier: x1

Hyperdrive Backup: No

Nav Computer: Yes, limited to 1 jump

Maneuverability: 3D+2

Space: 9

Atmosphere: 400; 1,150 kmh

Hull: 3D

Shields: 2D

Sensors:

Passive: 25/0D

Scan: 50/1D

Search: 75/2D

Focus: 3/4D

Weapons:

2 Assault Laser Cannons (fire-linked)

Fire Arc: Front

Crew: 1

Scale: Starfighter

Skill: Starship gunnery

Fire Control: 2D

Space Range: 1-5/10/17

Atmosphere Range: 100-500/1/1.7 km

Damage: 8D

2 Proton Torpedo Launchers

Fire Arc: Front

Crew: 1

Scale: Starfighter

Skill: Starship gunnery

Fire Control: 2D

Space Range: 1/3/7

Atmosphere Range: 100/300/700

Ammo: 4 missiles each

Damage: 9D



Capsule: The S-100 *Stinger*-class starfighter was a single-seat fighter produced by Corellian Engineering Corporation before, during, and after the Great Sith War of 3997 BBY. Measuring 11.5 meters in length, the hyperdrive-equipped craft was used by the Jedi Order, the navy of the Galactic Republic, and civilian purchase. Armed with laser cannons and proton torpedo launchers, and minimally shielded, the S-100 was considered lightly armed, but was said to make up for its defensive shortcomings with its high speed and maneuverability superior to most other starfighters of its time. Despite the introduction of other craft, the Stinger remained the mainstay of the Jedi, who used it in conflicts against the Krath during the Sith War and afterward, until the introduction of the Aurek tactical strike fighter before the Mandalorian Wars of 3976 BBY. Even then, the fighter remained in production, and was preferred by planetary defense forces.

Addendum Personal- General Han Solo

If you can believe it, there are still star systems that use

the S-100 fighters for planetary defense forces...

S-250

CHELA-CLASS STARFIGHTER

Craft: Corellian Engineering Corporation S-250 Chela-class Starfighter

Type: Space Superiority Fighter

Era: Old Republic

Affiliation: General

Source: KORSE p181. Converted from d20 Saga Edition rules; d6holocron

Scale: Starfighter

Length: 14 meters

Skill: Starfighter Piloting

Crew: 1

Cost: 420,000 credits (estimated, not for sale)

Passengers: 0

Cargo Capacity: 30 kilogram

Consumables: 1 week

Hyperdrive Multiplier: x2

Hyperdrive Backup: No

Nav Computer: yes

Maneuverability: 2D+1

Space: 10

Atmosphere: 415; 1,200 kmh

Hull: 4D

Shields: 1D+1

Sensors:

Passive: 30/0D

Scan: 60/1D

Search: None

Focus: None

Weapons:

2 Laser Cannons (fire-linked)

Fire Arc: Front

Crew: 1

Scale: Starfighter

Skill: Starship Gunnery

Fire Control: 2D

Space Range: 1-3/10/20

Atmosphere Range: 100-300/1/2 km

Damage: 5D

2 Concussion Missile Launchers (fire-linked)

Fire Arc: Front

Crew: 1

Scale: Starfighter

Skill: Starship Gunnery

Fire Control: 2D

Space Range: 1/3/7

Atmosphere Range: 100/300/700

Ammo: 6 missiles each

Damage: 10D



Capsule: Designed between the Great Sith War and the Mandalorian Wars, this design impressed the Republic Navy, though not as much as the Aurek fighter. It incorporates the agility of the earlier S-100 *Stinger*-class starfighter with improved weapons, and uses the unconventional thrusters-down landing position later seen on the Firespray transport used by Boba Fett.

Addendum Personal- General Han Solo

And now you know where the idea for the Firespray transport came from...

SS-19

CARGO TRANSPORT

Craft: Corellian Engineering Corporation SS-19 cargo transport

Type: Stock Light Freighter

Era: Rise of the Empire, Rebellion

Affiliation: General

Source: Challenge Magazine #73 with tweaking by Keith A. Kilburn

Scale: Starfighter

Length: 25 meters

Skill: Space Transports SS-19 cargo transport

Crew: 2

Passengers: 4

Cost: 100,000 new; 30,000 used

Cargo Capacity: 100 metric tons

Consumables: 1 month

Hyperdrive Multiplier: x1

Hyperdrive Backup: x10

Nav Computer: yes

Maneuverability: 2D

Space: 4

Atmosphere: 210; 1,200 kmh

Hull: 2D+2

Shields: 2D

Sensors:

Passive: 20/1D

Scan: 40/1D

Search: 50/2D

Focus: 2/2D

Weapons:

2 Double Laser Cannons

Fire Arc: Front and rear

Crew: 1

Scale: Starfighter

Skill: Starship gunnery

Fire Control: 1D

Space Range: 1-3/12/25

Atmosphere Range: 100-300/1.2/2.5 km

Damage: 4D

Capsule: The SS-19 Cargo Transport was a model of light freighter produced by the Corellian Engineering Corporation in the time prior to the blockade of Naboo and sold on the market until shortly before the Clone Wars. Armanda Durkin, CEO of Shipping on Taatooine, owned a highly modified SS-19 named the *Vengeful Sandstorm*.

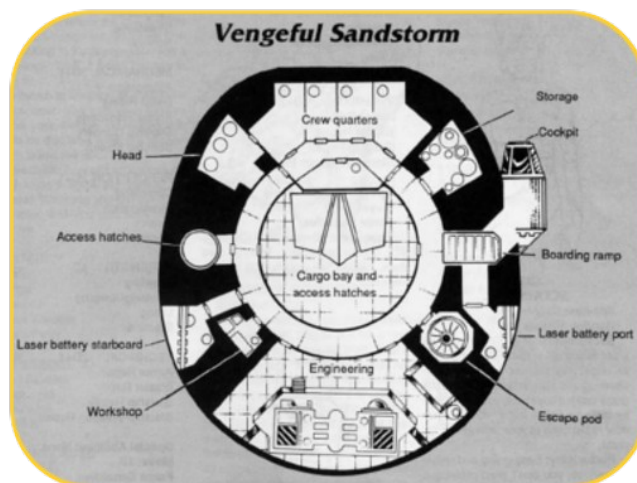

Addendum Personal- General Han Solo

When the YT-1300s were put into production there were a number of them that didn't pass quality control for a variety of reasons. Mostly it has to do with the molding work or the welding that was done to the interior. The CEC, after all, doesn't intentionally release ships onto the market where the interior of the vessel was miscast or welded incorrectly, that's simply not good business. Well, those miscasts were collected and there was enough that the issues in question were fairly minor so the CEC put them together and made the SS-19 line of vessels from the miscasts. I'm told that is why the loading ramp cuts off the cockpit when the ship is in a landed position, it wasn't an intentional design flaw it had to do more with the automated droids that constructed the ship were misprogrammed in the measurements of the ships and it wasn't noticed until there were thousands made...

STARRUNNER CLASS STARSHIP

Atmosphere Range: 100-300/1.2/2.5 km
Damage: 5D

Capsule: The *Starrunner*-class starship was a model of transport from CEC. It was 31 meters long. Though not on the market as of 0 ABY, a CSA employee owned such a ship.

Craft: Corellian Engineering Corporation
Starrunner-class starship

Type: Space transport

Era: Old Republic, Rise of the Empire, Rebellion

Affiliation: General

Source: Droids : The Animated Series,
Polyhedron #170 and stats by Keith Kilburn

Scale: Starfighter

Length: 31 meters

Skill: Space transports: Starrunner-class starship

Crew: 1

Crew Skill: Varies

Passengers: 6

Cost: 100,000 credits (new); 30,000 credits (used)

Cargo Capacity: 20 metric tons

Consumables: 3 months

Hyperdrive Multiplier: x3

Hyperdrive Backup: x12

Nav Computer: Yes

Space: 4

Atmosphere: 360; 1,000 kmh

Hull: 4D

Shields: 1D

Sensors:

Passive: 25/1D

Scan: 50/2D

Search: 75/2D+2

Focus: 3/3D

Weapons:

2 Laser Cannons (fire-linked)

Fire Arc: Front

Crew: 1

Scale: Starfighter

Skill: Starship gunnery

Fire Control: 2D

Space Range: 1-3/12/25

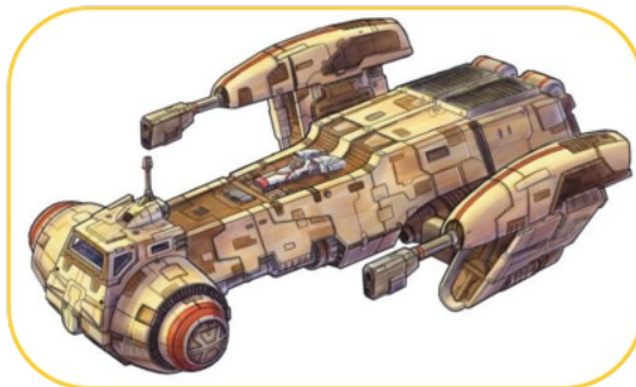

Addendum Personal- General Han Solo

My wife's droid, C-3P0, claims to have been on one of these, I'll spare you the details...

TZ-6

EXECUTIVE SHUTTLE

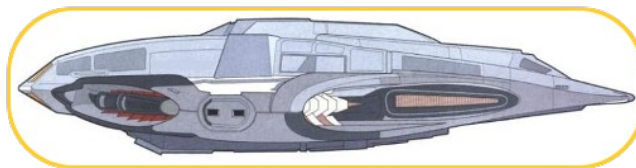

Craft: Corellian Engineering Corporation TZ-6 executive shuttle

Type: Shuttle

Era: Rise of the Empire

Affiliation: General

Source: Wookieepedia, stats by +Oliver Queen

Scale: Starfighter

Length: 50 meters

Skill: Space transports: TZ-6

Crew: 2 (pilot, steward), gunners: 1; skeleton: 1/+0

Passengers: 12

Cargo Capacity: 100 metric tons

Consumables: 1 month

Cost: 50,000 credits (used)

Hyperdrive Multiplier: x2

Hyperdrive Backup: x14

Nav Computer: Yes

Maneuverability: 1D

Space: 5

Atmosphere: 295; 850 kmh

Hull: 3D

Shields: 1D

Sensors:

Passive: 15/1D

Scan: 25/1D+2

Search: 45/2D

Focus: 4/3D

Capsule: The TZ-6 executive shuttle was a type of luxury shuttle produced by Corellian Engineering Corporation that was available during 3640 BBY on up through 3440 BBY and was widely sold and highly regarded for its elegance and opulence. Jedi Master Gnost-Dural owned one such shuttle called Prosperity as part of his cover as a wealthy businessman during the Operation End Game.

Addendum Personal- General Han Solo

I'm not really old enough to say much about the TZ-6 since it was sold thousands of years before I was born and despite what my children and their Wookiee life-nanny will tell you, I'm not that old. However from what I've gathered they were popular shuttles that were sold and produced with specifications that look suspiciously like a freighter with their cargo capacity and speed. Their lack of weaponry makes sense for a shuttle, but necessitates that they have escort vehicles to protect the occupants of the vehicles at all times...

VANGUARD

HEAVY ASSAULT GUNSHIP

Craft: Corellian Vanguard-class Heavy Assault Gunship
Type: Fighter
Era: Rise of the Empire
Affiliation: General
Source: Polyhedron Magazine 161 (pages 12-13)
Scale: Starfighter
Length: 47 meters
Skill: Starfighter piloting: Vanguard
Crew: 6 (pilot, co-pilot, navigator, engineer), gunners: 2; Skeleton: 1/+7
Crew Skill: All appropriate skills at 4D+1
Passengers: 6
Cargo Capacity: 220 kilograms
Consumables: 2 weeks
Cost: 115,700 (new), 69,500 (used)
Hyperdrive Multiplier: x2
Hyperdrive Backup: x14
Nav Computer: Yes
Maneuverability: 2D
Space: 7
Atmosphere: 350; 1,000 kmh
Hull: 5D+1
Shields: 2D
Sensors:

Passive: 20/0D
Scan: 35/1D
Search: 40/2D
Focus: 2/3D

Weapons:

2 Turbolasers (fire-linked)

Fire Arc: Front
Crew: 1
Scale: Capital
Skill: Capital Ship gunnery
Fire Control: 2D
Space Range: 3-15/35/75
Atmosphere Range: 6-30/70/150 km
Damage: 4D

2 Blaster Cannons (fire-linked)

Fire Arc: Turret
Crew: 1
Scale: Starfighter
Skill: Starship gunnery
Fire Control: 2D
Space Range: 1-5/10/17
Atmosphere Range: 100-500/1/1.7 km
Damage: 5D

4 Proton Torpedo Launchers

Fire Arc: Front
Crew: Pilot or Co-Pilot
Scale: starfighter
Skill: Starship gunnery
Fire Control: 2D
Space Range: 1/3/7
Atmosphere Range: 100/300/700
Ammo: 8 torpedoes each
Damage: 9D

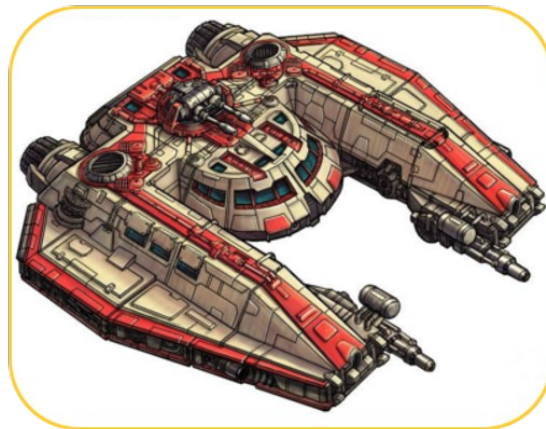

Capsule: The *Vanguard*-class heavy assault gunship was an assault vessel manufactured by the CEC during the time of the Galactic Empire.

Addendum Personal- General Han Solo

The Vanguard is a huge gunship with lots of weapons. If you want to engage in a running fight with someone that you're chasing then the Vanguard is the way to go, just make sure that you're the one flying the gunship and not the other way around...

WUD-500

STAR YACHT

Craft: WUD-500 Star Yacht

Type: Yacht

Era: Rise of the Empire

Affiliation: General

Source: Gamer Magazine Issue 4+ Stat tweaking
by Keith Kilburn

Type: Star yacht

Scale: Starfighters

Length: 18.5 meters

Skill: Space transports: WUD-500

Crew: 1

Crew Skill: Varies widely

Passengers: 7

Cargo Capacity: 10 metric tons

Consumables: 2 months

Cost: 185,000 (new), 92,500 (used)

Hyperdrive Multiplier: x1

Hyperdrive Backup: x8

Nav Computer: Yes

Maneuverability: 1D

Space: 5

Atmosphere: 295; 850 kmh

Hull: 3D+2

Shields: 1D

Sensors:

Passive: 20/1D

Scan: 40/2D

Search: 60/3D

Focus: 3/3D+2

Weapons:

Laser Cannon

Fire Arc: Front

Crew: 1 (pilot or co-pilot)

Scale: Starfighter

Skill: Starship gunnery

Fire Control: 1D

Space Range: 1-3/12/25

Atmosphere Range: 100-300/1.2/2.5 km

Damage: 4D

Capsule: The WUD-500 was an outdated CEC star yacht design, with features similar to the freighters of the *YT*-series. It was also called a *N*-class freighter. The Corporation intended to bring up a popular luxury craft besides their popular freighter designs. They, however, could never gain as much acceptance on the luxury market as *SoroSuub*. It measured 18.5 meters in length and could be operated without great difficulty by a single pilot. As for cargo-space, the WUD-500 had room enough for three metric tons of cargo, as well as being able to take seven passengers. However, sole smugglers required such vessels, as it features excellent sublight engines and hyperdrive suit as well as a fair weapons complement for a ship of its size. The smuggler *Jaxxon* owned and modified a WUD-500 which he named the *Rabbit's Foot*.

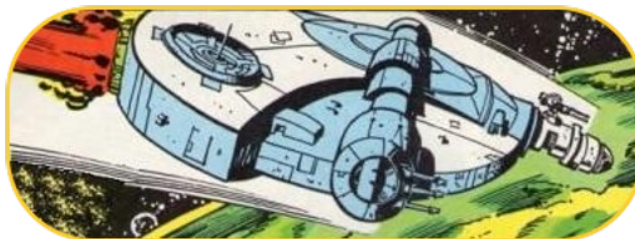

Addendum Personal- General Han Solo

The WUD-500 is a decent enough space yacht, how Jaxxon ever got a hold of one is a story let to be told. The problem that any owner runs into buying a yacht and converting it into a cargo vessel is that yachts are not designed to haul cargo, but rather transport the powerful and wealthy of the universe around while they are busy livin' it up...

Y-8

MINING VESSEL

Craft: Corellian Engineering Corporation Y-8 Mining Vessel

Type: Mining vessel

Era: Rise of the Empire

Affiliation: General

Source: wookieepedia, stats by +Oliver Queen

Scale: Starfighter

Length: 80 meters

Skill: Space transports: Y-8

Crew: 3 (pilot, 2 ops station personnel), gunner: 4; skeleton: 1/+5

Passengers: 4

Cargo Capacity: 3,000 metric tons

Consumables: 4 months

Hyperdrive Multiplier: x4

Hyperdrive Backup: x9

Nav Computer: Yes

Space: 2

Atmosphere: 100; 400 kmh

Hull: 3D

Shields: 1D (capital scale)

Sensors:

Passive: 100/1D

Scan: 200/2D

Search: 400/3D

Focus: 50/4D

Weapons:

2 Mining Lasers (fire-linked)

Fire Arc: Front

Crew: 1

Scale: Capital

Skill: Capital ship gunnery

Fire Control: 3D

Space Range: 1/3/7

Atmosphere Range: 30-100/300/700

Damage: 3D

2 Tractor Beam Projectors (fire separately)

Fire Arc: 2 Turret

Crew: 1

Scale: Capital

Skill: Capital ship gunnery

Space Range: 1-5/15/30

Damage: 4D

(modification) Turbolaser Battery

Fire Arc: Turret

Crew: 1

Scale: Capital

Skill: Capital ship gunnery

Fire Control: 3D

Space Range: 3-15/36/75

Atmosphere Range: 6-15/72/150 km

Damage: 5D

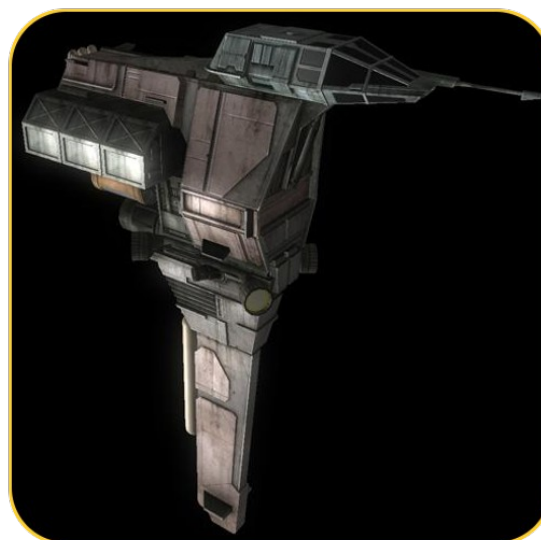

Game Notes: While the Heavy Mining Laser was designed for strip mining on planets, it has occasionally been adapted by daring and unscrupulous scouts and pirates as a deadly ship-destroying weapon. If a pilot can “land” it on top of another vessel – or fly right above it – the laser can cut through the hull of most small ships quite easily.

Capsule: The Y-8 was a Corellian Engineering Corporation mining vessel dominated mining operations throughout the galaxy. Designed as the ultimate in mining technology, equipped with a full array of lasers and

MISCELLANEOUS SHIPS

tractor beams for mining lucrative asteroid belts. It was equipped with heavy shielding for protection from pirates and meteors. Some mercenary groups that acquired Y-8's stripped them of their mining lasers and equipped them with more lethal laser cannons for use as capital ships.

Addendum Personal- General Han Solo

According to Chewbacca's cousin Kryzah, the Y-8 is widely considered to be the poorest choice of ships for mining asteroids in an 8-10 poll of Wookiees asked...

YCAQT CLASS DROID CARGO SHIP

Craft: CEC/Loronar Ycaqt-class Droid Cargo Ship

Type: Space transport

Era: Rebellion

Affiliation: General

Source: Gamer Magazine Issue 10

Scale: Starfighter

Length: 21 meters

Skill: Space transports: Ycaqt

Crew: Droid brain

Crew Skill: Astrogation 4D, Sensors 4D, Space Transports 4D, Starship Gunnery 4D, Starship Shields 4D

Passengers: None

Cargo Capacity: 250 metric tons

Consumables: 2 years

Cost: 130,000 credits (new), 32,000 credits (used)

Hyperdrive Multiplier: x2

Hyperdrive Backup: x12

Nav Computer: Yes

Maneuverability: 1D

Space: 6

Atmosphere: 250; 720 kmh

Hull: 4D

Shields: 2D

Sensors:

Passive: 10/0D

Scan: 25/1D

Search: 40/2D

Focus: 2/3D

Weapons:

Ion Cannon

Fire Arc: Turret

Crew: 1

Scale: Starfighter

Skill: Starship gunnery

Fire Control: 2D

Space Range: 1-3/7/36

Atmosphere Range: 100-300/700/3.6 km

Damage: 5D

Capsule: A product of the Nerfworks design group, the Ycaqt-class droid transport was named after a rather stubborn riding beast native to Velmor, a planet on the Mid Rim. The initial idea was to create a droid cargo ship capable of hauling large amounts of freight on short runs along secure hyperspace lanes. Nerfworks hoped the ship would revolutionize space transport, but while able pilots, the droid brain lacked the negotiating fervor of sentient captains. They also all too frequently became lost during hyperspace jumps, arriving at their programmed destination sometimes weeks, even months late.



Ycaqt droid brains also had a reputation for 'prissiness' similar to that of most protocol droids and tended to get trigger-happy with ships that refused to maintain a respectful distance. Most Ycaqts, however, were armed with only ion weapons and nothing heavier. Some large corporations found Ycaqts to be economical—especially once their hyperspace routes were re-programmed—but the majority of cargo was still hauled by independent freighter captains. 21 meters long with a cargo capacity of 250 metric tons, the Ycaqts had no room for interior crew, but one or more ASP labor droids could be found stationed in the cargo area.

Addendum Personal- General Han Solo

I'm still not a fan of droid automated ships with weapons...

YM-2800

LIMPET SHIP

Craft: Corellian Engineering Corporation YM-2800 Limpet Ship

Type: Boarding ship

Era: Rebellion

Affiliation: Alliance to Restore the Republic

Source: Saga D6 Conversion: Rebellion Era Campaign Guide (p.13)

Scale: Starfighter

Length: 26 meters

Skill: Space transports: limpet ship

Crew: 6; skeleton: 3/+10

Passengers: 6

Cargo Capacity: 125 metric tons

Consumables: 2 months

Cost: 150,000 credits (new), 70,000 credits (used)

Maneuverability: 0D

Space: 4

Move: 289; 800 kmh

Shields: +2

Sensors:

Passive: 10/1D

Scan: 25/2D

Search: 50/3D

Focus: 4/4D

Weapons:

2 Medium Laser Cannons (fire-linked)

Fire Arc: Front

Crew: 1

Scale: Starfighter

Skill: Starship gunnery

Fire Control: 2D

Space Range: 1-3/12/25

Atmosphere Range: 100-300/1.2/3.5 km

Damage: 4D

Plasma Beam Cutter

Fire Arc: Bottom

Crew: 2

Scale: Starfighter

Skill: Starship gunnery: plasma beam

Fire Control: 0D

Range: 4 meters

Damage: 8D

Game Notes: The plasma cutter, originally designed to mine asteroids, can be used to drill into a starship, creating a breach through which a zero-g boarding party can enter. While the cutter is in operation, weapons and shields lose all power. The pilot must make a successful opposed piloting roll against its target to attach the limpet ship to the hull. Roll the target ship's hull 2D; if the cutter's damage roll scored a "lightly damage" result, it has breached the hull. Once the hull is breached, the torch requires 8 rounds to cut a two-meter wide hole.



Capsule: The YM-2800 limpet ship was a survey and mining vessel used by the Rebel Alliance to deploy troopers into Imperial starships. Though possessing heavy particle shielding, YM-2800s were not equipped with ray shields. As a mining vessel, the limpet was designed to attach itself to the surface of a planet or an asteroid, then use plasma beam cutters to cut through the rocky surface to valuable materials below. However, the Rebel Alliance came up with the idea of using these ships to breach and board enemy space vessels. Usually it was freighters and storehouses that were assaulted, but occasionally military vessels were attacked as well.

Addendum Personal- General Han Solo

MISCELLANEOUS SHIPS

The idea for using these sorts of vessels to do the sorts of things they talk about in the capsule actually came from, and I hate to admit this, Grand Admiral Thrawn using the same trick during his campaign of terror against the fledgling New Republic...

YQ-400

Craft: CEC/Loronar YQ-400 Monitor Droid Patrol Ship

Type: Space Transport

Era: Old Republic, Rise of the Empire, Rebellion

Affiliation: General

Source: Conversion-Star Wars Gamer 10

Scale: Starfighter

Length: 36 meters

Skill: Space Transports: YQ-400

Crew: 0

Crew Skill: Sensors 4D, Space Transports 4D, Starship Gunnery 4D, Starship Shields 4D

Passengers: 0

Cargo Capacity: None

Consumables: 20 years

Cost: 175,000 credits (new), 100,000 credits (used)

Maneuverability: 2D

Space: 8

Atmosphere: 336; 960 kmh

Hull: 4D

Shields: 2D

Sensors:

Passive: 50/1D

Scan: 50/2D

Search: 75/2D+2

Focus: 4/3D+1

Weapons:

2 Dual Heavy Ion Cannons

Fire Arc: Partial Turret (front, left, right)

Crew: 1

Scale: Starfighter

Skill: Starship Gunnery

Fire Control: 1D

Space Range: 1-3/7/36

Atmosphere Range: 100-300/700/3.6 km

Damage: 8D

2 Laser Cannons (fire-linked)

Fire Arc: Front

Crew: 1

Scale: Starfighter

Skill: Starship Gunnery

Fire Control: 1D

Space Range: 1-3/12/25

Atmosphere Range: 100-300/1.2/2.5 km

Damage: 5D

Capsule: A product of the jointly funded design team of the Loronar Corporation and Corellian Engineering Corporation known as The Nerfworks, the YQ-400 Monitor Droid Patrol Ship was a small (36 meters long) ship designed to work in areas where high docking fees and trade tariffs provided most of a system's profits. Its primary job was to detect, locate and follow ships entering the system, although the lack of hyperdrive limited the ship to local areas only. Designed for light patrol duty in well-traveled peaceful systems, the YQ-400 Monitor did not carry enough armaments to stop serious smugglers or pirates, nor was it smart enough to serve in a military capacity. It did however, work as a watch ship, most commonly in systems with heavy commerce and shipping, where crewing enough ships to cover all possible approach vectors was financially prohibitive.



Standard programming stationed the YQ-400 in a predefined vector in the outer reaches of a system, where its use of only passive sensors made it difficult for other ships' sensors to spot. Upon detection of another starship within its vicinity, the patrol ship would report the contact to spaceport control and hail the ap-

proaching craft. The YQ-400 would then 'monitor' the ship in question by following it and reporting periodically on its location until directed otherwise by spaceport control. The droid patrol ship was programmed never to fire on a ship unless attacked first. While this gave an unfair advantage to hostile ships, it kept the Monitors from accidentally attacking friendly ships.

Addendum Personal- General Han Solo

Despite the fact that my brother-in-law's best friend is his astromech droid, I wouldn't give it a weapon to save my life. Droids with guns are a really bad idea, they have no conscience when it comes human life and arming them has never come to anything good as far as I can remember...

YT-XC MINI/FIGHTER

Craft: Corellian Engineering YT-XC Mini/Fighter

Type: Mini fighter

Era: Old Republic, Rise of the Empire

Affiliation: General

Source: wookieepedia, stats by +Oliver Queen

Scale: Starfighter

Length: 3 meters

Skill: Starfighter: F-YT-XC

Crew: 1

Cargo Capacity: 500 kilograms

Consumables: 1 day

Cost: Not for sale publically (estimated 30,000 credits, used only)

Maneuverability: 1D+2

Space: 5

Atmosphere: 295; 950 kmh

Hull: 2D

Sensors:

Passive: 10/0D

Scan: 20/1D

Search: 30/2D

Focus: 2/2D+2

Weapons:

(modified variant) Twin Blaster Cannon

Fire Arc: Front

Crew: 1 (pilot)

Scale: Starfighter

Skill: Starship gunnery

Fire Control: 3D

Space Range: 1-3/12/25

Atmosphere Range: 100-300/1.2/2.5 km

Damage: 5D

(modified variant) Concussion Missile Launcher

Fire Arc: Front

Crew: 1 (pilot)

Scale: Starfighter

Skill: Starship gunnery

Fire Control: 2D

Space Range: 1/3/7

Atmosphere Range: 100/300/700

Ammo: 1 missile

Damage: 7D

Capsule: The YT-XC, later known as the "mini-fighter," was a small explorer craft designed to be housed within the YT-1300, concealed behind a hatch that outwardly appeared to be a docking ring. The ship was large enough to accommodate an adult male Wookiee. The craft was later equipped with two blaster cannons and concussion missiles.

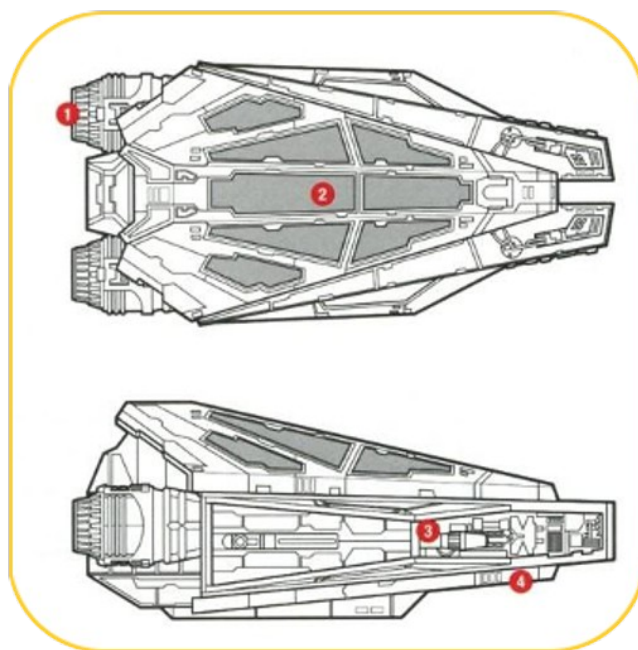

The YT-XC was a single-pilot exploration starship that was developed by the Corellian Engineering Corporation for use in conjunction with the YT-1300 light freighter. The YT-XC arose from research and development that had gone into the failed freight-loading external rover project. The vessel developed huge demand, but in response to concerns from Imperial Customs, CEC marketed it only at relief organizations, scientific foundations and licensed industrial prospectors. However, a number of YT-XCs were obtained by pir-

ates and smugglers, who modified them and used them as miniature starfighters.

Addendum Personal- General Han Solo

The YT-XC was designed for a mini-shuttle craft that could be hidden in modified YT-models. What the capsule doesn't tell you is that the added weight cuts into your cargo capacity and in atmosphere causes the ship to list to the left due to the weight dispersal. This also takes your escape pod out of play because you're sacrificing it in order to get the YT-XC craft hidden in your craft, another downside to having this thing is that the design for the concealed area doesn't hold up to exterior damage very well and should you get caught concealing one of these things by the authorities without the proper permit ... well let's just say it ain't pretty.

YX-1980

SPACE TRANSPORT

Craft: Corellian Engineering Corporation YX-1980

Type: Efficiency cargo freighter

Era: Old Republic, Rise of the Empire, Rebellion

Affiliation: General

Source: +Oliver Queen

Scale: Starfighter

Length: 38 meters

Skill: Space transports: YX-1980

Crew: 2, skeleton: 1/+5

Passengers: 6

Cargo Capacity: 110 metric tons

Consumables: 2 months

Cost: 150,000 credits (new), 80,000 credits (used)

Hyperdrive Multiplier: x2

Hyperdrive Backup: x10

Nav Computer: Yes

Maneuverability: 2D+1

Space: 6

Atmosphere: 330; 950 kmh

Hull: 5D

Shields: 2D+2

Sensors:

Passive: 10/0D

Scan: 25/2D

Search: 40/3D

Focus: 2/4D

Weapons:

2 Medium Laser Cannons (fire-linked)

Fire Arc: Front

Crew: 1

Scale: Starfighter

Skill: Starship gunnery

Fire Control: 3D

Space Range: 1-5/10/17

Atmosphere Range: 100-500/1/1.7 km

Damage: 4D

Capsule: The YX-1980 was a well-defended cargo hauler that could move goods across the galaxy with a minimum amount of fuss. It wasn't as fast as other transports, but was very durable. It had shields far stronger than most transports, and was equipped with a set of medium blaster cannons for defense. The ship had an open platform, which allowed it to spread out the cargo over a larger area to reduce strain on the repulsors and artificial gravity systems. It also helped prevent damage to other systems during a malfunction. Some owners liked this separation, but others complained about the problems this caused during operations or when attempting modifications. Like most CEC designs, it was very easy to customize. It had plenty of room for modifications or new systems. This

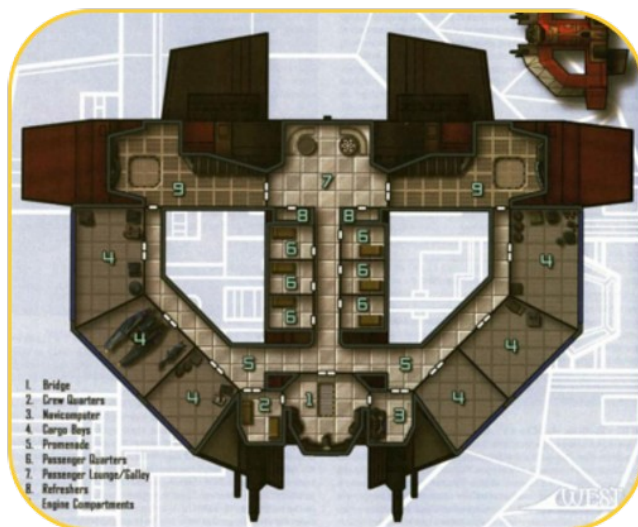

made it popular with captains who liked to customize their ships.

Addendum Personal- General Han Solo

This has to be one of the stranger looking ships that the CEC ever sold, I'm not sure what the thought was where the giant holes through the center of the ship are concerned, however I can tell you from experience that the air current in atmosphere would push this ship towards the ground the faster you go thus making it harder and less efficient to take off from a landing platform...

